



**CAMBRIDGE**  
International Examinations

Cambridge  
**O Level**

# Example Candidate Responses (Standards Booklet)

Cambridge O Level  
Physics  
**5054**

Cambridge Secondary 2

<https://xtremepape.rs/>

Cambridge International Examinations retains the copyright on all its publications. Registered Centres are permitted to copy material from this booklet for their own internal use. However, we cannot give permission to Centres to photocopy any material that is acknowledged to a third party even for internal use within a Centre.

© Cambridge International Examinations February 2015

---

## Contents

---

Introduction.....	2
Assessment at a glance.....	3
Paper 2 Theory .....	4
Paper 4 Alternative to Practical .....	81

---

## Introduction

---

The main aim of this booklet is to exemplify standards for those teaching Cambridge O Level Physics (5054), and to show how different levels of candidates' performance relate to the subject's curriculum and assessment objectives.

In this booklet a range of candidate responses to questions in Papers 2 and 4 have been chosen as far as possible to exemplify grades A, C and E. Each response is accompanied by a brief commentary explaining the strengths and weaknesses of the answers. This booklet does not cover Paper 1 as it contains multiple-choice questions where the mark scheme provides sufficient detail and the candidate answers do not require examiner commentary to expand on how the marks were gained.

Grades are given to each answer in this booklet, however in the examination the whole candidate script is graded on the overall mark awarded, not on each question. It is therefore possible that, for some questions, lower grade candidate answers are awarded the same or similar marks to higher grade candidate answers.

For ease of reference the following format for each paper has been adopted:

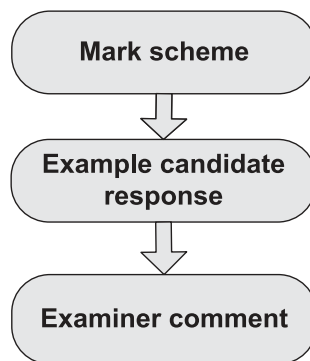

An extract of the mark scheme used by examiners, is followed by examples of marked candidate responses, each with an examiner comment on performance. Comments are given to indicate where and why marks were awarded, and how additional marks could have been obtained. In this way, it is possible to understand what candidates have done to gain their marks and what they still have to do to improve their grades.

Past papers, examiner reports and other teacher support materials are available on Teacher Support at <http://teachers.cie.org.uk>



## Assessment at a glance

<b>Paper 1: Multiple Choice</b>		<b>1 hour</b>
<p>40 compulsory multiple-choice questions of the direct choice type. The questions involve four response items.</p> <p>40 marks</p>		
<b>Paper 2: Theory</b>		<b>1 hour 45 minutes</b>
<p>This paper has two sections:</p> <p>Section A has a small number of compulsory, structured questions of variable mark value. 45 marks in total are available for this section.</p> <p>Section B has three questions. Each question is worth 15 marks. Candidates must answer <b>two</b> questions from this section.</p> <p>There is no compulsory question on Section 25 of the syllabus (Electronic systems). Questions set on topics within Section 25 appear only in Paper 2 and are always set as an alternative within a question.</p> <p>75 marks</p>		
<b>Paper 3: Practical Test</b>	<b>2 hours</b>	<b>Paper 4: Alternative to Practical</b>
<p>This paper has two sections.</p> <p>Section A has three compulsory questions each carrying five marks and each of 20 minutes duration.</p> <p>Section B has one question of 15 marks and is of one hour's duration.</p> <p>30 marks</p>		<p>A written paper of compulsory short-answer and structured questions designed to test familiarity with laboratory practical procedures.</p> <p>30 marks</p>

Teachers are reminded that the full syllabus is available at [www.cie.org.uk](http://www.cie.org.uk)

---

## Paper 2 Theory

---

### Question 1

#### Mark scheme

- 1 (a) (i) **D and either** lorry accelerates (forward) **or** resultant force is forward [B1]
- (ii) air resistance **or** (air) drag **or** friction (between tyres and road) [B1]
- (b) (i) 30 000 kg [B1]
- (ii) (a=)  $F/m$  algebraic in any form or numerical [C1]  
0.5(0)  $m/s^2$  [A1]
- (c) direction or velocity is changing **or** acceleration or force is sideways or towards centre (of circle) [B1]
- [6]

Example candidate response – grade A

1 Fig. 1.1 shows a lorry accelerating in a straight line along a horizontal road.



Fig. 1.1

(a) The driving force on the lorry in the forward direction is  $D$  and the total backward force on the lorry is  $B$ .

(i) State and explain whether  $D$  or  $B$  is the larger force.

Since the object is accelerating, the speed is increasing, hence the driving force  $D$  is greater or larger than  $B$ . [1]

(ii) Suggest one possible cause of the backward force  $B$ .

A friction between the road and tires. [1]

(b) The weight of the lorry is 300 000 N.

The gravitational field strength  $g$  is 10 N/kg.

(i) Calculate the mass of the lorry.

$W = mg$   
 $m = \frac{W}{g} = \frac{300\,000}{10}$   
 $\therefore \text{Mass} = 30\,000 \text{ kg}$  mass = ..... 30 000 kg ..... [1]

(ii) The resultant force on the lorry is 15 000 N. Calculate the acceleration of the lorry.

$F = ma$   
 $a = \frac{F}{m} = \frac{15\,000}{30\,000}$   
 $\therefore \text{Acceleration} = 0.5 \text{ m/s}^2$  acceleration = ..... 0.5 m/s<sup>2</sup> ..... [2]

(c) Later, the lorry turns a corner at constant speed.

Explain why the lorry accelerates even though the speed is constant.

Since the velocity of the lorry changes (due to change in direction), it accelerates. [1]

## Examiner comment – grade A

- (a) A well-reasoned explanation has been produced explaining why D is larger than B and the frictional force has even been correctly describes as being between the road and the tyres, which was not essential but shows understanding. (2/2)
- (b) The formulae are both stated correctly in algebraic form before the insertion of numerical values and the units are correct for both of the final answers. The detail given is often helpful to the examiners. (3/3)
- (c) The candidate correctly states not only that the velocity changes when turning the corner but that this is because the direction has changed, showing a good understanding of circular motion at this level. (1/1)

**Total mark awarded = 6 out of 6**

Example candidate response – grade C

1 Fig. 1.1 shows a lorry accelerating in a straight line along a horizontal road.



Fig. 1.1

(a) The driving force on the lorry in the forward direction is  $D$  and the total backward force on the lorry is  $B$ .

(i) State and explain whether  $D$  or  $B$  is the larger force.

As lorry is accelerating that means that forward force ( $D$ ) is greater than force  $B$ .  $D > B$  [1]

(ii) Suggest one possible cause of the backward force  $B$ .

Air resistance [1]

(b) The weight of the lorry is 300 000 N.

The gravitational field strength  $g$  is 10 N/kg.

(i) Calculate the mass of the lorry.

$W = mg$   
 $\frac{300000}{10} = m$   
 $30000 \text{ kg}$   
 $W = 300000$   
 $g = 10 \text{ N/kg}$   
 $m = ?$   
 mass = 30000 kg [1]

(ii) The resultant force on the lorry is 15 000 N. Calculate the acceleration of the lorry.

$F = ma$   
 $30000 - 15000 = 30000 \times a$   
 $\frac{28500}{30000} = a$   
 acceleration = 9.5 m/s<sup>2</sup> [2]

(c) Later, the lorry turns a corner at constant speed.

Explain why the lorry accelerates even though the speed is constant.

As lorry is making a turn, so it needs to accelerate [1]

## Examiner comment – grade C

- (a)** The simple statement that the lorry is accelerating is enough to explain why D is the larger force in **(i)** and the choice of air resistance is suitable for the backward force B in **(ii)**. (2/2)
- (b)** The correct equation was used to find the mass from the weight in **(i)**, even though there is an extra zero in one value quoted for the weight. Although the correct formula was used to find acceleration in **(ii)** and the final unit is correct, the force to be used in  $F = ma$  should always be the resultant force. In this answer, the candidate has wrongly attempted to combine weight and the resultant force and was not awarded full marks. (2/3)
- (c)** Not enough knowledge was shown of circular motion and the answer merely repeats aspects of the question. Candidates should realise that repeating the question does not earn any credit and reduces the space for the actual answer. (0/1)

**Total mark awarded = 4 out of 6**

Example candidate response – grade E

1 Fig. 1.1 shows a lorry accelerating in a straight line along a horizontal road.



Fig. 1.1

(a) The driving force on the lorry in the forward direction is  $D$  and the total backward force on the lorry is  $B$ .

(i) State and explain whether  $D$  or  $B$  is the larger force.

$D$  is larger force which means  $B$  ..... [1]

(ii) Suggest one possible cause of the backward force  $B$ .

friction in tyres ..... [1]

(b) The weight of the lorry is 300000N.

The gravitational field strength  $g$  is 10N/kg.

(i) Calculate the mass of the lorry.

$W = mg$   
 $300000N = m(10N/kg)$   
 $m = 30000kg$       mass = 30000kg ..... [1]

(ii) The resultant force on the lorry is 15000N. Calculate the acceleration of the lorry.

$F = ma$   
 $15000N = (30000kg) a$   
 $a = 2 m/s$       acceleration = 2 m/s ..... [2]

(c) Later, the lorry turns a corner at constant speed.

Explain why the lorry accelerates even though the speed is constant.

Due to ~~inert~~ ~~inertia~~ which is higher ~~inertia~~  
~~inertia~~ of the lorry and weight of the lorry. ..... [1]



## Examiner comment – grade E

- (a) The candidate has stated in (i) that D is the larger force but has not explained how the question shows that it is the larger force, for example by stating that the lorry is accelerating in the forwards direction. A reasonable suggestion was made as to the cause of the backwards force, although the friction is not within the tyres but between the tyres and the road. (1/2)
- (b) The correct formula and calculation was used to find the mass of the lorry but in using the formula  $F = ma$  there has been an arithmetic mistake and the final unit is also incorrect. The candidate does, however, show knowledge of the formula and so one mark was awarded in (ii). (2/3)
- (c) No understanding was shown of circular motion. (0/1)

**Total mark awarded = 3 out of 6**



## Question 2

### Mark scheme

- 2 (a) (i) (P=)  $F/A$  algebraic in any form or numerical [C1]  
 $33 \text{ N/cm}^2$  or  $3.3 \times 10^5 \text{ N/m}^2$  [A1]
- (ii) 170 N or 167 N or 166.7 N or (i)  $\times 5$  with unit [B1]
- (b) volume (of oil) remains the same  
 or oil passes from small(er) to large(r) area  
 or work =  $Fd$  and force large so distance small [B1]
- (c) output  $\div$  input or fraction or percentage of work mentioned [C1]  
 complete definition, e.g. useful work obtained  $\div$  (total) work put in [A1]
- [6]

## Example candidate response – grade A

2 Fig. 2.1 shows part of a hydraulic jack used to lift the front of a car.

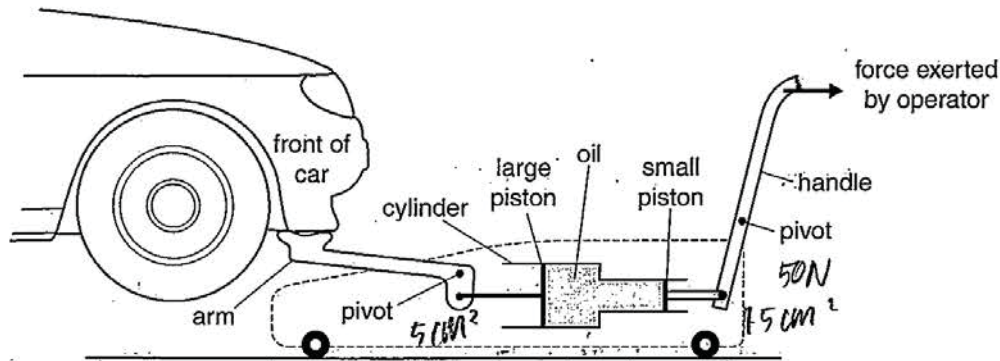

Fig. 2.1 (not to scale)

The operator pulls the handle and causes a force of 50 N to act on the small piston. The force exerted by the oil on the large piston increases by  $F$ . The large piston moves and rotates the arm about the pivot. This raises the front of the car.

The cross-sectional area of the small piston is  $1.5 \text{ cm}^2$ .  
The cross-sectional area of the large piston is  $5.0 \text{ cm}^2$ .

(a) Calculate

(i) the pressure in the oil caused by the force on the small piston,

$$p = \frac{F}{A} = \frac{50}{1.5} = 33.33 \text{ Pa}$$

pressure =  $33.33 \text{ Pa}$  [2]

(ii) the value of  $F$ .

$$p = \frac{F}{A} \quad F = 33.33 \times 5 = 166.65 \text{ N}$$

$F = 166.65 \text{ N}$  [1]

(b) Explain why the large piston moves through a shorter distance than the small piston.

The large piston has a larger area when compared to the small piston.  
The volume of large piston that moved has to be equal to the volume moved by the small piston. [1]

(c) The efficiency of the jack is 75%. Explain what is meant by *efficiency*.

Efficiency means total useful energy output over the total energy input multiplied by 100%. It also means the percentage of usefulness. [2]

### Examiner comment – grade A

- (a)** The equation for calculating pressure was correct but the final unit should have been  $\text{N}/\text{cm}^2$  and not Pa as the area used in the equation was in  $\text{cm}^2$  and not  $\text{m}^2$ . The area could have been changed to  $1.5 \times 10^{-4} \text{ m}^2$  if the answer had to be in Pa but there is no need to make this change. In **(ii)** the candidate realised that the pressure was the same on both pistons and successfully calculated the answer to earn full marks. (2/3)
- (b)** It was not sufficient to just state that the large piston has a larger cross-sectional area but this answer successfully goes on to explain that the volume of the oil that passes from the smaller to the larger piston is the same and thus the piston moves through a smaller distance. (1/1)
- (c)** The candidate provides a good definition of efficiency, which was sufficient and mentioned useful energy output rather than total energy output. There was no need to relate the efficiency to the actual efficiency of the jack itself. (2/2)

**Total mark awarded = 5 out of 6**

### Example candidate response – grade C

2 Fig. 2.1 shows part of a hydraulic jack used to lift the front of a car.

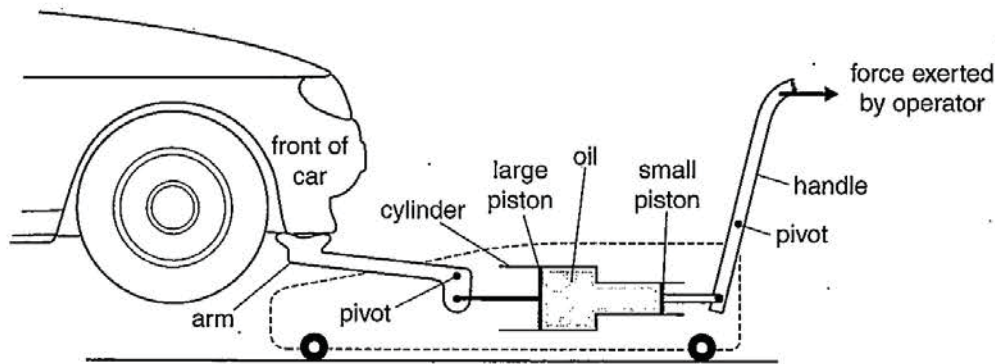

Fig. 2.1 (not to scale)

The operator pulls the handle and causes a force of 50 N to act on the small piston. The force exerted by the oil on the large piston increases by  $F$ . The large piston moves and rotates the arm about the pivot. This raises the front of the car.

The cross-sectional area of the small piston is  $1.5 \text{ cm}^2$ .  
The cross-sectional area of the large piston is  $5.0 \text{ cm}^2$ .

(a) Calculate

(i) the pressure in the oil caused by the force on the small piston,

$$P = F/A$$

$$= 50 \div 1.5$$

pressure =  $33.3 \text{ Pa}$  ..... [2]

(ii) the value of  $F$ .

$$P = F/A \quad \therefore \quad F = P \times A$$

$$5.0 \times 33.3 = F$$

$F = 165 \text{ N}$  ..... [1]

(b) Explain why the large piston moves through a shorter distance than the small piston.

Since the force exerting on large piston is larger than the force exerting of the small piston, the large piston ~~moves~~ moves a shorter distance due to the large pressure on it. [1]

(c) The efficiency of the jack is 75%. Explain what is meant by *efficiency*.

centage, Ratio of output energy and input energy. .... [2]

### Examiner comment – grade C

- (a) The candidate used the formula correctly but the unit should have been  $\text{N/cm}^2$  with the values that were used. The calculation of force in (ii) was correct using the actual value for pressure calculated in (i). (2/3)
- (b) The candidate realised that the force on the smaller piston was larger but, in comparing the distance moved by the two pistons, did not relate these forces to the work being done on the two pistons but incorrectly stated that the smaller distance of movement was due to the larger pressure. (0/1)
- (c) Some understanding was shown of efficiency in the statement provided but the full answer required the understanding that useful output energy (or power) is involved. (1/2)

**Total mark awarded = 3 out of 6**

## Example candidate response – grade E

2 Fig. 2.1 shows part of a hydraulic jack used to lift the front of a car.

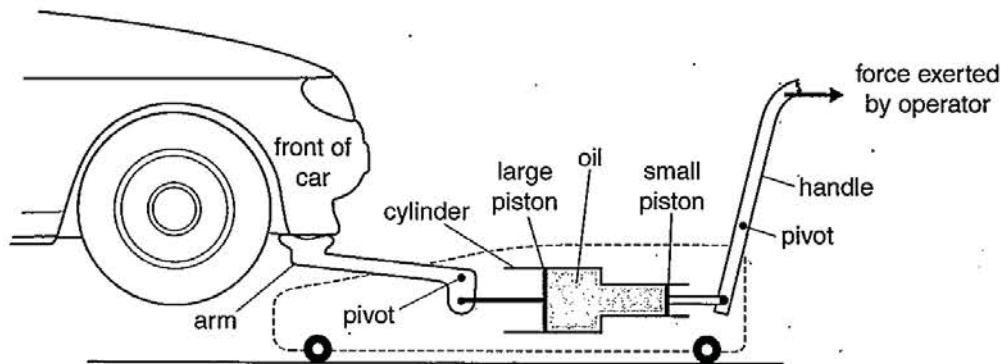

Fig. 2.1 (not to scale)

The operator pulls the handle and causes a force of 50 N to act on the small piston. The force exerted by the oil on the large piston increases by  $F$ . The large piston moves and rotates the arm about the pivot. This raises the front of the car.

The cross-sectional area of the small piston is  $1.5 \text{ cm}^2$ .  
The cross-sectional area of the large piston is  $5.0 \text{ cm}^2$ .

(a) Calculate

(i) the pressure in the oil caused by the force on the small piston,

$$\text{pressure} = \frac{50}{1.5} = 33.3 \text{ N}$$

$$\text{pressure} = \dots\dots\dots 33.3 \dots\dots\dots [2]$$

(ii) the value of  $F$ .

$$F = \frac{50 \text{ N}}{5.0} = 10 \text{ N}$$

$$F = \dots\dots\dots 10 \text{ N} \dots\dots\dots [1]$$

(b) Explain why the large piston moves through a shorter distance than the small piston.

because the large force exerted on the large piston to raise the front of car so the small piston have small force act on it. [1]

(c) The efficiency of the jack is 75%. Explain what is meant by *efficiency*.

Efficiency is the percentage of # the power of the jack. [2]



### Examiner comment – grade E

- (a) Knowledge was shown of the formula for calculating pressure by the use of the correct numbers but the attempt at giving the unit for the final answer only produced the unit of N for the pressure. In this particular question, the unit can be worked out from the data used as  $\text{N}/\text{cm}^2$ . In (ii) the candidate is not using the same pressure calculated as in (i) and so no mark could be awarded. (1/3)
- (b) No attempt is made to compare the distance of movement of the two pistons. Rather the answer appears to try and explain why one force is larger than the other. (0/1)
- (c) No real understanding was shown of efficiency. Had the answer suggested that efficiency is the percentage of the power of the jack that is output, or better that efficiency is the percentage of the input power that becomes useful output power, then marks would have been awarded. (0/2)

**Total mark awarded = 1 out of 6**

## Question 3

### Mark scheme

- 3 (a) (i)** any sensible example where expansion is useful [B1]
- (ii) any sensible example where expansion causes a problem [B1]
- (b)** (molecules) move fast(er) or vibrate fast(er) or have more (kinetic/potential/internal) energy [B1]
- (molecules) move apart or distance between molecules increases or vibration has larger amplitude or vibration takes up more space or bonds stretch [B1]
- (c)** slightly smaller [B1]  
much larger [B1]
- [6]



## Example candidate response – grade A

3 Most substances expand when they are heated.

(a) (i) State one example where expansion is useful.

.....Cooking food..... [1]

(ii) State one example where expansion causes a problem.

.....Sagging of electrical cables on pylons..... [1]

(b) Explain, using ideas about molecules, why solids expand when heated.

.....When solids are heated, the molecules in the solids gain kinetic energy and begin to vibrate more vigorously about their fixed positions. In doing so, each molecule transfers kinetic energy to its neighbouring molecule and this weakens the forces of attraction between the molecules of the solid. [2]

(c) When equal volumes are heated through the same temperature rise, the expansions of solids, liquids and gases are different.

Complete each of the two sentences using one of these expressions:

**much larger      slightly larger      much smaller      slightly smaller**

1. The expansion of a solid is .....slightly smaller..... than the expansion of a liquid.

2. The expansion of a gas is .....much larger..... than the expansion of a liquid. [2]

## Examiner comment – grade A

(a) In (i) it was not clear how expansion is involved in the cooking of food. Had the example suggested that water expands and sets up a convection current that would have been sufficient. The example quoted in (ii) was sufficient as the problem was clearly expressed as the sagging of electrical cables. Many answers merely suggested, for example 'electrical cables' or 'railway tracks', which was not sufficient but this example gave the detail that ensures that expansion is a problem. (1/2)

(b) The idea of a more vigorous vibration with more kinetic energy was well expressed but there was no clear link to an increase in the separation of the molecules, only that the force of attraction between the molecules is weaker. (1/2)

(c) Both answers were correct. (2/2)

**Total mark awarded = 4 out of 6**

## Example candidate response – grade C

3 Most substances expand when they are heated.

(a) (i) State one example where expansion is useful.

To separate substances. [1]

(ii) State one example where expansion causes a problem.

It is difficult to return it back to its original form. [1]

(b) Explain, using ideas about molecules, why solids expand when heated.

When heated, the molecules in a solid move faster. They collide more frequently. The collisions are also high energy collisions - so, the molecules of the solid expand. which expands the solid.

[2]

(c) When equal volumes are heated through the same temperature rise, the expansions of solids, liquids and gases are different.

Complete each of the two sentences using one of these expressions:

**much larger**      **slightly larger**      **much smaller**      **slightly smaller**

1. The expansion of a solid is *slightly smaller* than the expansion of a liquid.

2. The expansion of a gas is *much larger* than the expansion of a liquid. [2]

## Examiner comment – grade C

(a) The statement is too brief for it to be clear that expansion is involved. Slightly more detail is necessary, such as heating the top on a bottle to separate it from the bottle in (i) and a railway track may buckle and not come back to its original form. (0/2)

(b) The answer clearly states that molecules move faster and so the first mark can be awarded. However it is not clear for the second mark that the molecules move apart. The molecules themselves do not expand; they stay the same size but the distance between them increases. (1/2)

(c) Both answers are correct and so both marks are awarded. (2/2)

**Total mark awarded = 3 out of 6**

### Example candidate response – grade E

3 Most substances expand when they are heated.

(a) (i) State one example where expansion is useful.

.....solid..... [1]

(ii) State one example where expansion causes a problem.

.....in a beaker..... [1]

(b) Explain, using ideas about molecules, why solids expand when heated.

because when the solid molecules heated it gains kinetic energy the molecules vibrating and colliding so the molecules expand when heated. It gain enough energy to break the forces of attraction. [2]

(c) When equal volumes are heated through the same temperature rise, the expansions of solids, liquids and gases are different.

Complete each of the two sentences using one of these expressions:

**much larger      slightly larger      much smaller      slightly smaller**

1. The expansion of a solid is ~~much larger~~ <sup>slightly</sup> larger than the expansion of a liquid.

2. The expansion of a gas is ~~slightly smaller~~ than the expansion of a liquid. [2]

### Examiner comment – grade E

(a) The situation where expansion is useful is not stated at all in (i) and in (ii) it was necessary to state a clear situation where expansion was a problem. No mark was earned because no useful or problematic examples were given. The examples stated needed to have a clear link to a use for expansion, e.g. mercury expanding in a thermometer or a problem such as railway tracks bending. (0/2)

(b) The first mark could be clearly awarded for the recognition that the kinetic energy of the molecules increases. There is also the indication that the molecules are vibrating more, although it would not be helpful to say that molecules start to vibrate. The mark would not be awarded for the idea that molecules themselves expand but here it appears that a change of state was being described as the molecules break free from each other. This clearly meant the second 1 mark could not be awarded. (1/2)

(c) Both ideas were incorrect and so no mark was earned. The answer suggested that solids expand more than liquids and that gas expands less than liquid. (0/2)

**Total mark awarded = 1 out of 6**

## Question 4

### Mark scheme

- 4 (a) (i) up and down clear, e.g. by double headed arrow **or** down [B1]
- (ii) any correct distance between consecutive points in phase [B1]
- (iii) correct distance [B1]
- (b) measure number of oscillations / count waves (passing) in a stated time or time at least one oscillation [B1]  
show how to calculate number of oscillations per second [B1]
- (c) **moves** (hand or rope) with slow(er) speed or rate / less frequency / less times per sec [B1]
- [6]



## Example candidate response – grade A

4 Fig. 4.1 shows part of a long rope used by a student to show a transverse wave.

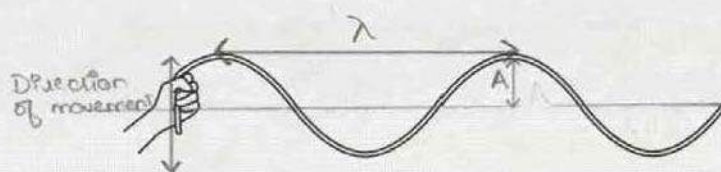

Fig. 4.1

(a) On Fig. 4.1,

- (i) mark the direction of movement of the student's hand, [1]
- (ii) mark and label the wavelength  $\lambda$  of the wave, [1]
- (iii) mark and label the amplitude  $A$  of the wave. [1]

(b) Describe how the frequency of the wave is found using a stopwatch.

The student moves his hand and the stopwatch is started and the stopwatch is stopped when one complete wave is produced then the time period frequency is found by putting time period in the formula:  $f = 1/T$  [2]

(c) Using the same rope, the student produces a wave of a longer wavelength than that shown in Fig. 4.1.

State how the student does this.

By moving the hand with much more stretched rope and increasing the speed of movement. [1]

## Examiner comment – grade A

- (a) The direction of the arrow was drawn correctly and labelled clearly as were the amplitude and wavelength. Some care was taken with the diagram as shown by drawing the middle line. (3/3)
- (b) There was a reasonable description of finding the time for one wave and using this to find the frequency of the wave. For full marks, candidates needed to time more than one wave and then calculate frequency or notice how many waves passed a point in a time greater than one second and then calculate the number per second. (1/2)
- (c) The candidate has made two suggestions, neither of which will increase the wavelength of the wave on the rope shown. (0/1)

**Total mark awarded = 4 out of 6**

## Example candidate response – grade C

4 Fig. 4.1 shows part of a long rope used by a student to show a transverse wave.

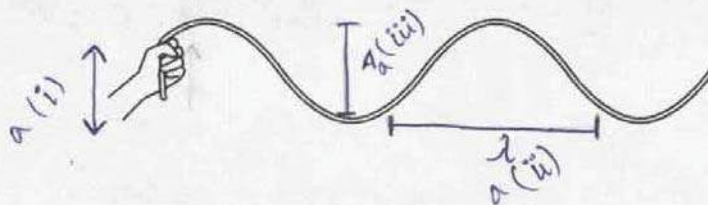

Fig. 4.1

(a) On Fig. 4.1,

- (i) mark the direction of movement of the student's hand, [1]
- (ii) mark and label the wavelength  $\lambda$  of the wave, [1]
- (iii) mark and label the amplitude  $A$  of the wave. [1]

(b) Describe how the frequency of the wave is found using a stopwatch.

By using a stopwatch, the frequency is determined as a wave is formed and the wavelength is measured.  $\lambda$  time is recorded by stopwatch. By dividing <sup>these</sup> values frequency is obtained. For accurate results, average is taken. [2]

(c) Using the same rope, the student produces a wave of a longer wavelength than that shown in Fig. 4.1.

State how the student does this.

The student moves his hand upward and back to initial position in a longer interval of time. [1]

## Examiner comment – grade C

- (a) The candidate drew a double headed arrow to show the direction of movement of the hand in making a transverse wave. A single arrow downwards would also be correct as the hand is moving downwards in the part of the cycle shown. The answer to (ii) shows a length that is from top to bottom of the wave rather than from the top to the middle. Some candidates drew the middle line to make the correct distance clear. The mark in (iii) was not awarded as the arrow drawn is too short. A little more care was needed to draw a line from one trough to the next. (1/3)
- (b) There is no clear idea of how the stopwatch is used to time at least one wave and then calculate the frequency. Most candidates did at least describe how to measure the period of time for one wave. (0/2)
- (c) The candidate gave a sensible and well described account of taking longer to make one wave and thus increasing the wavelength. (1/1)

**Total mark awarded = 2 out of 6**

## Example candidate response – grade E

4 Fig. 4.1 shows part of a long rope used by a student to show a transverse wave.

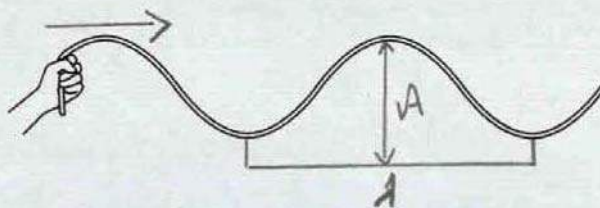

Fig. 4.1

(a) On Fig. 4.1,

- (i) mark the direction of movement of the student's hand, [1]
- (ii) mark and label the wavelength  $\lambda$  of the wave, [1]
- (iii) mark and label the amplitude  $A$  of the wave. [1]

(b) Describe how the frequency of the wave is found using a stopwatch.

By starting a stop watch the time of the wave will come and then through the time its frequency also come which is inversely proportional to each other. [2]

(c) Using the same rope, the student produces a wave of a longer wavelength than that shown in Fig. 4.1.

State how the student does this.

by decreasing the amplitude and by changing the direction of his hand. [1]

## Examiner comment – grade E

- (a) The direction of movement shown was incorrect for a transverse wave in (i) and the length drawn to represent the amplitude was twice the required length. However the wavelength was drawn with some care and accuracy. (1/3)
- (b) The description of how to find the time for one wave has been attempted but it is not clear enough for even one mark. A description of finding the time for the hand to move up and down at least once or the time for, say, 10 waves to pass a point would have improved the answer considerably. It was recognised that a calculation was necessary to convert the 'time of the wave' to frequency but the calculation was not explicit in the relationship quoted. (0/2)
- (c) Neither of the two suggestions quoted in the answer will produce a wave of larger wavelength. It is sometimes counterproductive to quote two answers when only one is required because if one is clearly wrong, in this case by suggesting that changing the direction of the hand alters the wavelength, then no mark may be scored even if the other answer is correct. (0/1)

**Total mark awarded = 1 out of 6**



## Question 5

### Mark scheme

- 5 (a) ultra violet **and** infra-red [B1]
- (b) blue refracts/bends/deviates more [B1]  
blue slows more (than red when entering glass) or blue and red have different speeds (from each other in glass) [B1]  
blue and red have different refractive indices [B1]
- [4]



## Example candidate response – grade A

5 Visible light, radio waves, X-rays, gamma rays and microwaves are some of the components of the electromagnetic spectrum.

(a) State two other components of the electromagnetic spectrum.

1. .... Ultraviolet rays .....  
 2. .... Infrared rays ..... [1]

(b) White light is a mixture of different colours.

Fig. 5.1 shows a ray of white light entering a glass prism.

The white light separates into a number of colours. Only the blue light and the red light are shown.

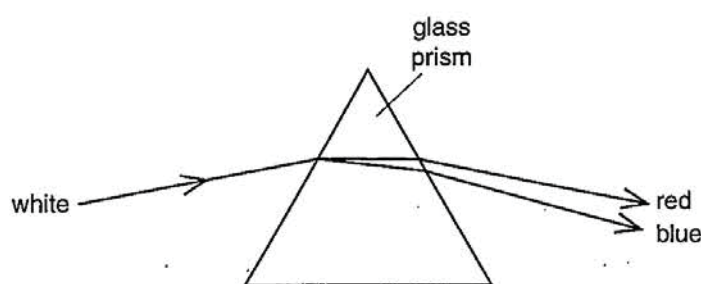

Fig. 5.1

Explain why the blue light and the red light separate as shown.

Use the term *refractive index* in your answer.

..... The blue light has a higher frequency than .....  
 the red light. Its <sup>wavelength</sup> speed ~~become~~ <sup>changes</sup> .....  
~~more~~ <sup>less</sup> than the red light. Therefore the .....  
 refractive index for blue light is more than .....  
 the refractive index for red light. Its speed ..... [3]  
<sup>decreases</sup> ~~changes~~ more than the red light.

## Examiner comment – grade A

(a) Both infra-red and ultra violet are the acceptable extra components of the electromagnetic spectrum. (1/1)

(b) The candidate clearly understands that the two colours have different refractive indices and explains further that this is because the speed decreases more for blue than red light and it is taken that this decrease is as the light enters the glass. Some initial statements about frequency and wavelength, although correct are not the reason for the decrease in speed. The answer would have improved by describing how the difference in refractive index causes the separation to differ; indeed separation is not mentioned in the answer. (2/3)

**Total mark awarded = 3 out of 4**

## Example candidate response – grade C

5 Visible light, radio waves, X-rays, gamma rays and microwaves are some of the components of the electromagnetic spectrum.

(a) State two other components of the electromagnetic spectrum.

1. Ultraviolet rays

2. X-rays

[1]

(b) White light is a mixture of different colours.

Fig. 5.1 shows a ray of white light entering a glass prism.

The white light separates into a number of colours. Only the blue light and the red light are shown.

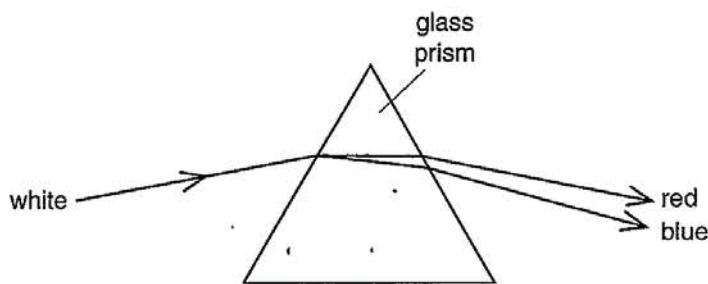

Fig. 5.1

Explain why the blue light and the red light separate as shown.

Use the term *refractive index* in your answer.

As the white light enters to a denser medium (prism) from less dense medium (air) it refracts then bends due to the refractive index of prism. The white light then disperse into it's components as it leaves the prism and red & blue light separates due to their different <sup>speeds (wavelengths)</sup> ~~refractive index~~ [3]

## Examiner comment – grade C

(a) Although both the components stated are in the electromagnetic spectrum, the mark cannot be awarded because X-rays have already been mentioned in the question and are not another component of the spectrum. (0/1)

(b) A sensible description of refraction and the separation has been given but the question asks for an explanation of the separation, using the term refractive index. There is no mention that the refractive index of red and blue are different or that this causes blue to refract more as it enters or leaves the prism. There is, however, some indication that blue and red light travel at different speeds. It would have been more helpful if the dispersion had happened as the light enters as well as leaves the glass and had the difference in speeds been clearly in the glass as there was some indication that the difference in speeds may have been after leaving the prism; however there was enough indication that the separation was caused by the different speeds of the two colours to award one mark. (1/3)

**Total mark awarded = 1 out of 4**

### Example candidate response – grade E

5 Visible light, radio waves, X-rays, gamma rays and microwaves are some of the components of the electromagnetic spectrum.

(a) State two other components of the electromagnetic spectrum.

1. ~~x~~ ultra violet ray waves
2. sound waves

[1]

(b) White light is a mixture of different colours.

Fig. 5.1 shows a ray of white light entering a glass prism.

The white light separates into a number of colours. Only the blue light and the red light are shown.

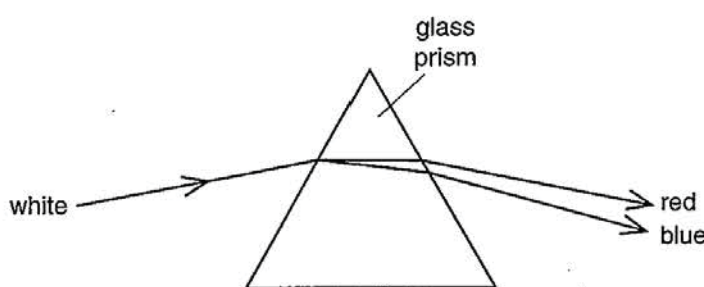

Fig. 5.1

Explain why the blue light and the red light separate as shown.

Use the term *refractive index* in your answer.

The white light ray after reflected from prism give different refractive index through which blue and red light are separated.

[3]

### Examiner comment – grade E

(a) Although ultra-violet is another part of the electromagnetic spectrum, sound is not and no mark was awarded. (0/1)

(b) The candidate has not quite suggested that the different colours in white light have different refractive indices in the glass and has, unfortunately, confused refraction and reflection. (0/3)

**Total mark awarded = 0 out of 4**

## Question 6

### Mark scheme

- 6 (a) (i)** any single value between 0 and 5.6 cm or a range all of whose values are correct [B1]  
(ii) any value beyond 5.6 cm [B1]
- (b) (i)** ray through optical centre undeviated [B1]  
other ray correct through or to axis 2.8 cm ( $\pm \frac{1}{2}$  small square) from lens [B1]
- (ii)** lines drawn meet after 11 cm or rays do not meet (on page) or rays almost parallel [B1]
- (iii)** inverted, magnified, real all 3 needed and none wrong [B1]
- [6]**



Example candidate response – grade A

6 (a) A beam of parallel light strikes a converging lens of focal length 2.8 cm.

The width of the beam before it reaches the lens is 1.0 cm. The width changes on the other side of the lens.

State a distance from the lens where the width of the beam is

(i) less than 1.0 cm,

2.2 cm ..... [1]

(ii) more than 1.0 cm.

0 cm ..... [1]

(b) An object is placed 3.0 cm from a converging lens of focal length of 2.8 cm. Fig. 6.1 is an incomplete, full-scale ray diagram for this arrangement.

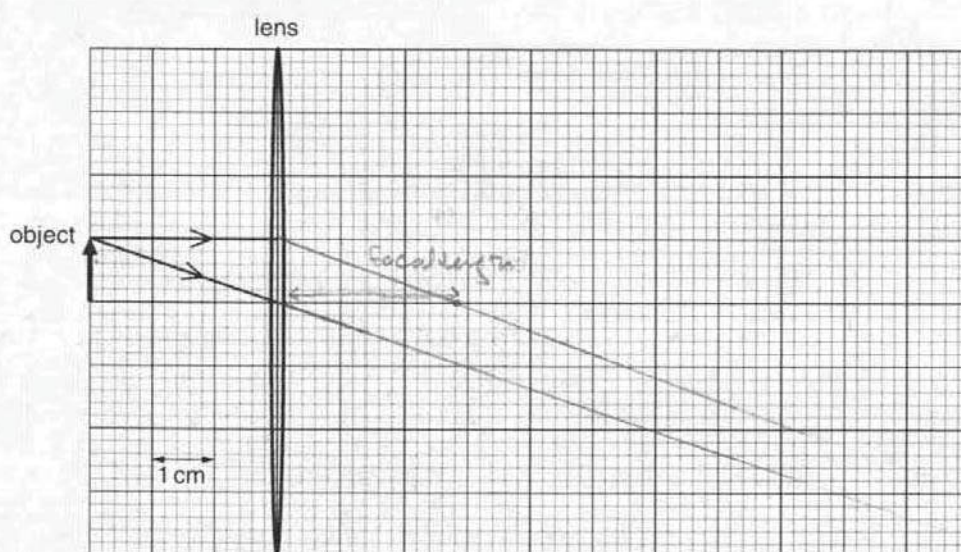

Fig. 6.1 (full scale)

(i) On Fig. 6.1, draw the paths of the two rays after they pass through the lens. [2]

(ii) Explain how your ray diagram shows that the image is more than 11 cm from the lens.

Because rays are ~~not~~ ~~converging~~ converging  
outside the graph. [1]

(iii) Underline **three** of the following words which describe the image.

diminished    inverted    magnified    real    upright    virtual [1]

## Examiner comment – grade A

- (a)** A correct answer was given in **(i)** but not in **(ii)**. Very good answers often showed that candidates had sketched a beam as it struck a lens and continued the beam on the other side of the lens to establish that the beam becomes wider than 1.0 cm at a distance more than 5.6 cm from the lens. (1/2)
- (b)** The correct ray diagram was drawn in **(i)** and some care was taken to make sure that the rays were drawn correctly. A long rule helps in drawing the rays correctly. In **(ii)** it is not true to suggest that rays are only converging outside the diagram as the rays are actually converging at all points on the diagram, but this answer was taken as indicating that the rays do not actually meet on the diagram and was awarded a mark in **(ii)**. In **(iii)** it is impossible for the image to be both diminished and magnified. (3/4)

**Total mark awarded = 4 out of 6**

Example candidate response – grade C

6 (a) A beam of parallel light strikes a converging lens of focal length 2.8 cm.

The width of the beam before it reaches the lens is 1.0 cm. The width changes on the other side of the lens.

State a distance from the lens where the width of the beam is

(i) less than 1.0 cm,

..... 1.8 cm ..... [1]

(ii) more than 1.0 cm.

..... 3.8 cm ..... [1]

(b) An object is placed 3.0 cm from a converging lens of focal length of 2.8 cm. Fig. 6.1 is an incomplete, full-scale ray diagram for this arrangement.

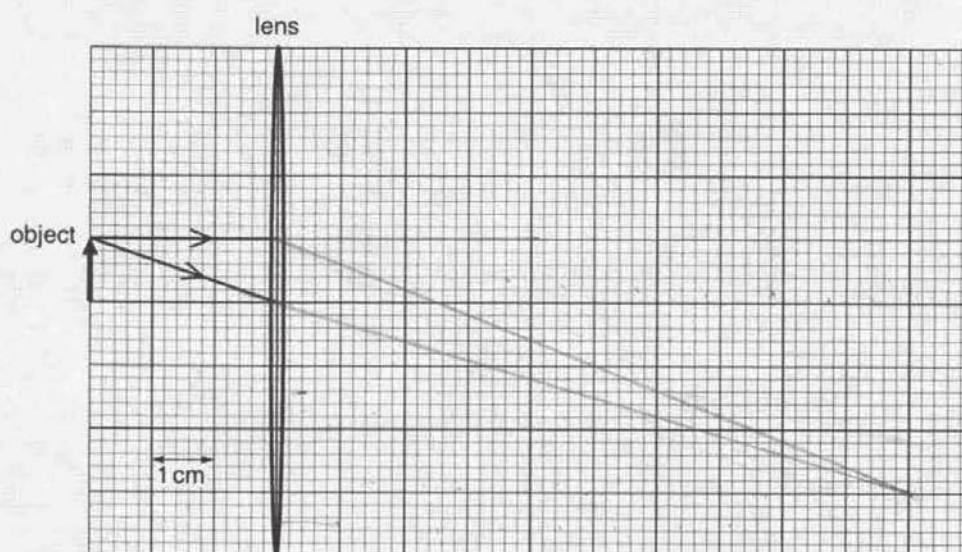

Fig. 6.1 (full scale)

(i) On Fig. 6.1, draw the paths of the two rays after they pass through the lens. [2]

(ii) Explain how your ray diagram shows that the image is more than 11 cm from the lens.

~~The image is magnified, inverted and real.~~  
 by calculating the distance between image and lens and it is far away from lens. [1]

(iii) Underline **three** of the following words which describe the image.

diminished    inverted    magnified    real    upright    virtual    [1]

## Examiner comment – grade C

- (a)** Any single value between 0 and 5.6 cm was accepted in **(i)** and the value quoted is in this range. However the value quoted in **(ii)** was not beyond  $2f$  from the lens and so the beam would still have been smaller than 1.0 cm in width. (1/2)
- (b)** The diagram in **(i)** clearly attempted to draw a ray undeviated through the optical centre of the lens and that was accepted even though it is slightly bent as it passes through the lens. The second ray through the focal point was not accurately drawn as it intersects the principal axis at 2.5 cm rather than 2.8 cm from the lens. The answer in **(ii)** does not use the ray diagram in the suggestion. The three underlined words clearly show that the candidate realised the correct properties of the image, even though it had not been shown on the ray diagram. (2/4)

**Total mark awarded = 3 out of 6**



## Example candidate response – grade E

- 6 (a) A beam of parallel light strikes a converging lens of focal length 2.8 cm.

The width of the beam before it reaches the lens is 1.0 cm. The width changes on the other side of the lens.

State a distance from the lens where the width of the beam is

- (i) less than 1.0 cm.

*the distance is less* ..... [1]

- (ii) more than 1.0 cm.

*the distance is more.* ..... [1]

- (b) An object is placed 3.0 cm from a converging lens of focal length of 2.8 cm. Fig. 6.1 is an incomplete, full-scale ray diagram for this arrangement.

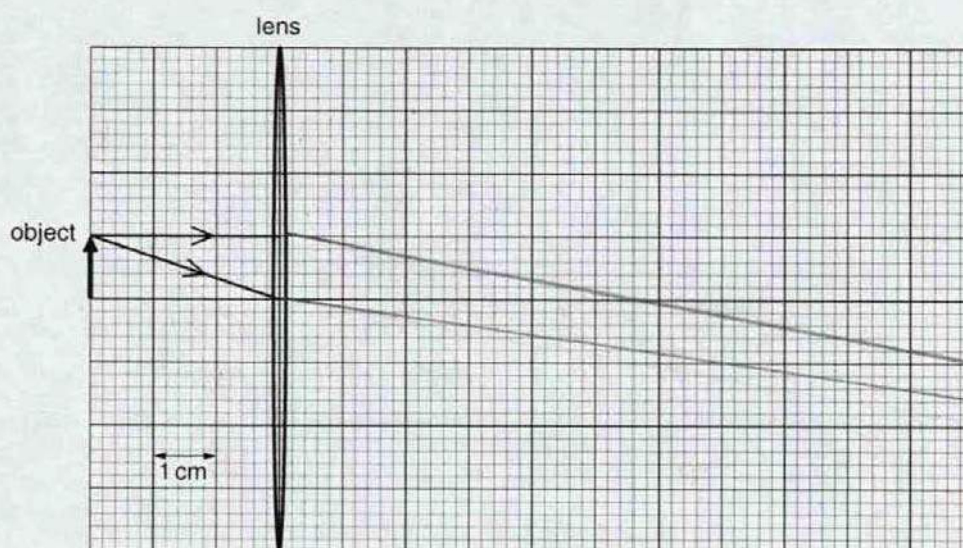

Fig. 6.1 (full scale)

- (i) On Fig. 6.1, draw the paths of the two rays after they pass through the lens. [2]

- (ii) Explain how your ray diagram shows that the image is more than 11 cm from the lens.

*because the ray does not meet within the 11cm from the lens to make image.* [1]

- (iii) Underline **three** of the following words which describe the image.

diminished    inverted    magnified    real    upright    virtual [1]

## Examiner comment – grade E

- (a)** The distances suggested in **(i)** and **(ii)** are not actual values. If the candidate had suggested that the distance was less than one or two focal lengths from the lens in **(i)** and more than  $2f$  from the lens in **(ii)** then those answers would have been correct. (0/2)
- (b)** Neither of the two rays drawn in the answer was correct and so no mark could be awarded in **(i)**. The idea is clearly and correctly expressed in **(ii)** that the rays do not meet within 11 cm from the lens. However in **(iii)** the image is not upright and, indeed, the candidate's rays would clearly have met in an inverted image and so no mark was earned in the last section. (1/4)

**Total mark awarded = 1 out of 6**

## Question 7

### Mark scheme

- 7 (a) (i) **horizontal** arrow to right (by eye) [B1]
- (ii) forces / resultant causes moment or (turns because) force is not at pivot [B1]
- (b) mark made at one end/pole/direction of compass (on paper) [B1]  
move compass so that other end of compass is on mark **and** remark [B1]  
join marks made as compass moved on in some way (to draw line) [B1]
- [5]

Example candidate response – grade A

7 Fig. 7.1 shows a compass needle near a bar magnet. Magnetic poles are shown on the compass needle and on the magnet.

A finger stops the compass needle from turning.

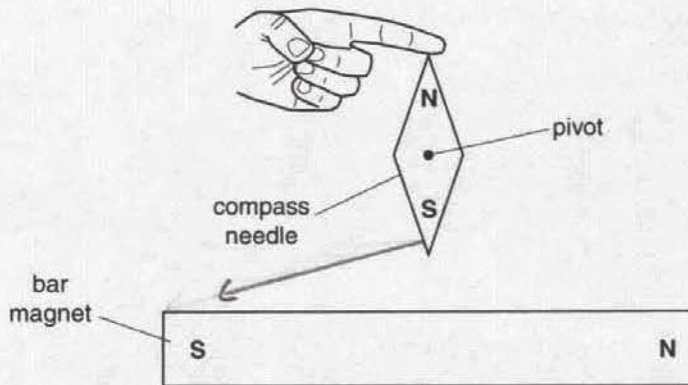

Fig. 7.1 (not to scale)

(a) (i) The magnet causes a force on the S-pole of the compass needle.

On Fig. 7.1, draw an arrow from the S-pole of the compass needle to show the direction of this force. [1]

(ii) Explain why the compass needle turns when the finger is removed.

The magnetic poles attract the compass needle. [1]

(b) A small compass is used to plot the magnetic field lines of the magnet.

Describe how the compass is used to plot magnetic field lines on a piece of paper.

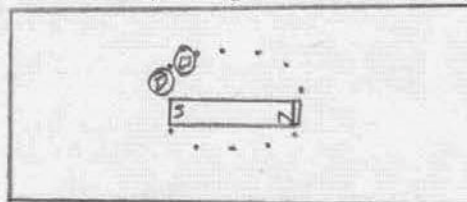

We take a plotting compass, a white paper and a bar magnet. We place the magnet on the paper and place the compass <sup>at</sup> the south end. The compass points in a direction and we place a dot on them. Now we place the compass before the dot and make another. We then join all the dots to show the magnetic field lines. [3]



## Examiner comment – grade A

- (a)** In **(i)** the needle is drawn as though the S-pole is attracted to the S-pole which is wrong. The S-pole of the compass is attracted to the N-pole of the magnet and repelled by the S-pole. The resultant force is not towards one of the poles but is horizontal. In **(ii)**, the question states that there is a force on the S-pole and asks why the needle turns. It does not ask why there is a force on the needle. The answer should refer in some way to the turning effect of the force, its moment or that the force does not pass through the pivot. This answer tries to explain why there is a force and not why it turns. (0/2)
- (b)** This is a good clear logical answer that sets out the experimental procedure clearly. Not only is the end of the compass marked but the movement of the compass is clearly described in words. The diagram drawn is also helpful as it shows two positions of the compass with the second compass aligned with the dot made by the first compass. (3/3)

**Total mark awarded = 3 out of 5**

Example candidate response – grade C

7 Fig. 7.1 shows a compass needle near a bar magnet. Magnetic poles are shown on the compass needle and on the magnet.

A finger stops the compass needle from turning.

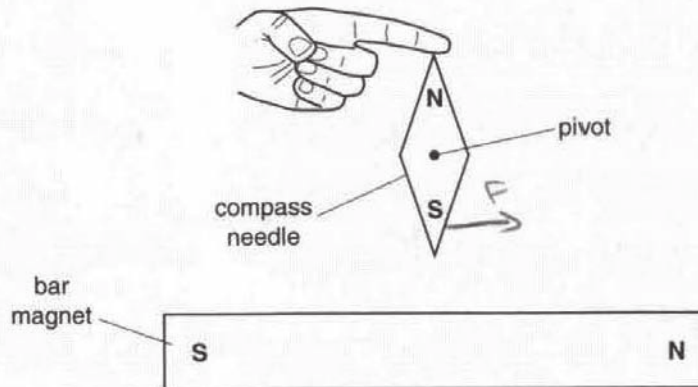

Fig. 7.1 (not to scale)

(a) (i) The magnet causes a force on the S-pole of the compass needle.

On Fig. 7.1, draw an arrow from the S-pole of the compass needle to show the direction of this force. [1]

(ii) Explain why the compass needle turns when the finger is removed.

when the finger is removed the needle would turn to show the direction magnetic field

(b) A small compass is used to plot the magnetic field lines of the magnet.

Describe how the compass is used to plot magnetic field lines on a piece of paper.

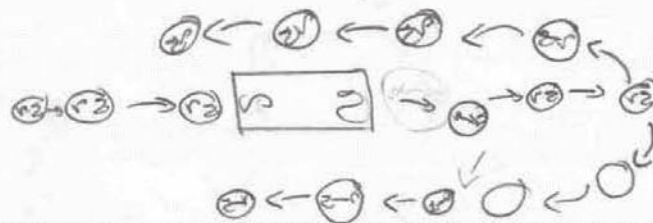

By putting the compass in N pole or S pole & put the arrow on a paper in a direction of a compass needle. [3]

## Examiner comment – grade C

- (a)** Although the arrow drawn on the S-pole in **(i)** is not perfectly horizontal or straight, the intention to draw the resultant force is clearly shown and this was awarded a mark. In **(ii)** there is some indication that the answer attempts to explain why the needle turns, but the answer would have improved with more explanation as to what causes a compass to align with the magnetic field. When a question asks for an explanation it is helpful to mention the relevant physical principles, in this case as to why an object turns. (1/2)
- (b)** The answer shows that the end of the compass needle is marked while the magnetic field is plotted and so this answer can score the first mark. The diagram seems to indicate that the compass is moved on but it is not explained in the text that the compass, or its end, is placed over the previous mark and the diagram shows compasses placed very far apart and so the second mark was not earned. There is no indication on the diagram or in the text that the marks made at each compass position are joined together. (1/3)

**Total mark awarded = 2 out of 5**

Example candidate response – grade E

7 Fig. 7.1 shows a compass needle near a bar magnet. Magnetic poles are shown on the compass needle and on the magnet.

A finger stops the compass needle from turning.

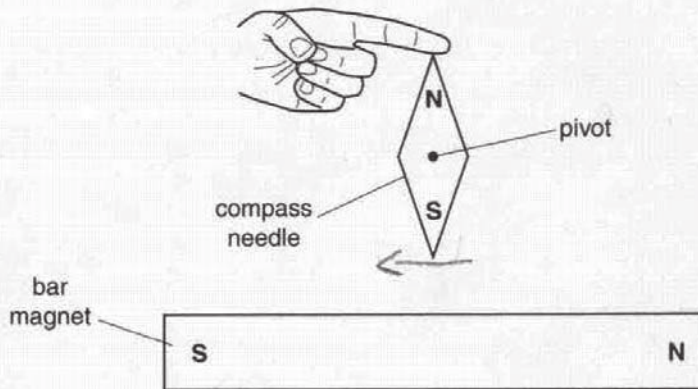

Fig. 7.1 (not to scale)

(a) (i) The magnet causes a force on the S-pole of the compass needle.

On Fig. 7.1, draw an arrow from the S-pole of the compass needle to show the direction of this force. [1]

(ii) Explain why the compass needle turns when the finger is removed.

It is attract by north pole. [1]

(b) A small compass is used to plot the magnetic field lines of the magnet.

Describe how the compass is used to plot magnetic field lines on a piece of paper.

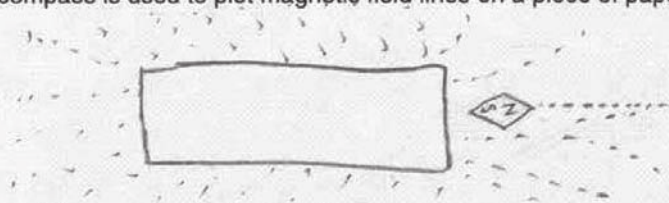

we can measure the magnetic feild line by moving the compass near magnet and make a dot line at the north pole of compass. Every side will have changed direction at north which tells us about magnetic feild. [3]



### Examiner comment – grade E

- (a)** Although horizontal and showing the resultant force, the arrow drawn in **(i)** is in the wrong direction. This was a fairly common mistake. In **(ii)** the question asks why the needle turns and not why there is a force. The detail given about the force is too vague. The use of the word 'it' suggests that the whole compass is attracted to the N-pole. (0/2)
- (b)** There was an indication that the end of the compass was marked but there was no statement or illustration that showed the compass being placed at different positions and so only the first mark could be awarded. (1/3)

**Total mark awarded = 1 out of 5**

## Question 8

### Mark scheme

- 8 (a) (i)** electron(s) and proton(s) [B1]
- (ii) neutron(s) and proton(s) [B1]
- (b) (i)** top box 14 [B1]  
bottom box 7 [B1]
- (c) (i)** sensible halving seen, e.g. 2.4 → 1.2 **or** two halves clear **or**  $\frac{1}{2} \times \frac{1}{2}$  seen [C1]  
11 400 **or** 11 000 years [A1]
- [6]

## Example candidate response – grade A

- 8 (a) An atom consists of electrons surrounding a nucleus made up of protons and neutrons.

State which of these particles

- (i) have an equal and opposite charge,

neutrons..... [1]

- (ii) have almost equal mass.

electrons and protons..... [1]

- (b) The nuclide notation for carbon-14 is  ${}^{14}_6\text{C}$ . Carbon-14 decays by beta emission to a stable isotope of nitrogen (N).

- (i) Write numbers in the empty boxes below to show the nuclide notation for this isotope of nitrogen.

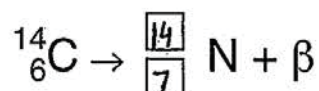

[2]

- (ii) The half-life of carbon-14 is 5700 years.

A sample of wood from a living tree contains  $2.4 \times 10^{12}$  atoms of carbon-14.

A similar sample of the same size is taken from an old piece of wood. It contains  $6.0 \times 10^{11}$  atoms of carbon-14.

Calculate the age of the old piece of wood.

$$\begin{array}{l} 2.4 \times 10^{12} \text{ (1)} \quad 1.2 \times 10^{12} \text{ (2)} \quad 6 \times 10^{11} \text{ (3)} \quad 3 \times 10^{11} \\ \text{(4)} \quad 1.5 \times 10^{11} \quad \text{(5)} \quad 7.5 \times 10^{11} \quad \text{and } 1.75 \times 10^{11} \end{array}$$

$$\text{age of wood} = 5700 \times 5$$

more than 28500 years

age = 28500 years..... [2]

## Examiner comment – grade A

- (a) The candidate has quoted neutrons as having a charge in **(i)** and suggested that electrons and protons have nearly the same mass in **(ii)** and so no marks were awarded for this knowledge of the structure of the atom. (0/2)
- (b) The values quoted for the proton number and nucleon number of the decay product were correct and full marks were earned in **(i)**. The calculation in **(ii)** showed a series that started by halving the initial number of atoms and this was sufficient to earn the first mark. Unfortunately the halving continued past the final number of atoms and so the number of half-lives and the final answer was incorrect. (3/4)

**Total mark awarded = 3 out of 6**

## Example candidate response – grade C

- 8 (a) An atom consists of electrons surrounding a nucleus made up of protons and neutrons.

State which of these particles

- (i) have an equal and opposite charge,

..... electron ..... [1]

- (ii) have almost equal mass.

..... proton ..... [1]

- (b) The nuclide notation for carbon-14 is  ${}^{14}_6\text{C}$ . Carbon-14 decays by beta emission to a stable isotope of nitrogen (N).

- (i) Write numbers in the empty boxes below to show the nuclide notation for this isotope of nitrogen.

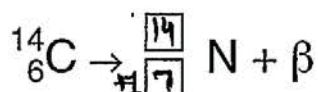

[2]

- (ii) The half-life of carbon-14 is 5700 years.

A sample of wood from a living tree contains  $2.4 \times 10^{12}$  atoms of carbon-14.

A similar sample of the same size is taken from an old piece of wood. It contains  $6.0 \times 10^{11}$  atoms of carbon-14.

Calculate the age of the old piece of wood.

half <sup>life</sup> Carbon-14 is 5700

Sample wood  $2.4 \times 10^{12}$

as it have more age  $6.0 \times 10^{11}$

as it  $\frac{6.0 \times 10^{11}}{2.4 \times 10^{12}} =$   
2 ~~3~~ time

It will decay 32 time.

age = ..... 182400 year old ..... [2]

## Examiner comment – grade C

- (a)** The answer needed to say both proton and electron in **(i)** and neutron and proton in **(ii)**. Only one of these particles was quoted in each case and so no mark was awarded. (0/2)
- (b)** The values quoted were correct and so full marks were earned in **(i)**. Although not necessary in this case it is worthwhile to show working within the answer and this may have helped in producing the correct answer to **(i)**. The working shown in **(ii)** seems to suggest that the sample decays, possibly by a factor of two, 32 times rather than twice to reduce  $2.4 \times 10^{12}$  to  $6.0 \times 10^{11}$ . It is advisable to show the halving simply as a series of stages, e.g.  $2.4 \times 10^{12} \rightarrow 1.2 \times 10^{12} \rightarrow 6.0 \times 10^{11}$  in this case to show that two half-lives have passed. It was not clear how the number 32 had been obtained and so no mark was awarded. (2/4)

**Total mark awarded = 2 out of 6**



Example candidate response – grade E

8 (a) An atom consists of electrons surrounding a nucleus made up of protons and neutrons.

State which of these particles

(i) have an equal and opposite charge,

..... Uranium ..... [1]

(ii) have almost equal mass.

..... Helium ..... [1]

(b) The nuclide notation for carbon-14 is  $^{14}_6\text{C}$ . Carbon-14 decays by beta emission to a stable isotope of nitrogen (N).

(i) Write numbers in the empty boxes below to show the nuclide notation for this isotope of nitrogen.

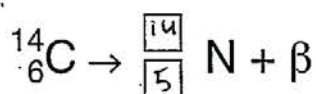

[2]

(ii) The half-life of carbon-14 is 5700 years.

A sample of wood from a living tree contains  $2.4 \times 10^{12}$  atoms of carbon-14.

A similar sample of the same size is taken from an old piece of wood. It contains  $6.0 \times 10^{11}$  atoms of carbon-14.

Calculate the age of the old piece of wood.

Handwritten calculations:

$$\frac{5700}{2} = \frac{2850}{2} = 1425$$

$$1425 \times 6.0 \times 10^{11}$$

Vertical division:  $5700 \div 2 = 2850$ ,  $2850 \div 2 = 1425$

age = ..... 8850 ..... [2]

## Examiner comment – grade E

- (a)** The candidate has suggested particles which are not mentioned in the list provided. When provided with a list, it is important to choose items from that list as the question asks candidates to use the particles stated. (0/2)
- (b)** The candidate appears to understand that the nucleon number is unchanged in beta decay but the proton number has been decreased and not increased by one. Overall in **(i)** one mark was earned. The candidate attempted in **(ii)** to halve the half-life a number of times and this was a common mistake. Candidates should expect to halve a count or, in this case, a number of atoms several times to find out the number of half-lives involved. (1/4)

**Total mark awarded = 1 out of 6**

## Question 9

## Mark scheme

- 9 (a) straight line from (0, 0) to (3, 2.4) [B1]  
 horizontal line from 3 s to 8 s [B1]  
 straight line from **end of a horizontal line** to zero in 1 s [B1]
- (b) constant/same increase in velocity **or constant** change in velocity [C1]  
 constant/same increase in velocity per sec/unit time [A1]
- (c) occurs in a short(er) time  
**or** acceleration took 3 s and deceleration took 1 s [B1]
- (d) (d =) speed  $\times$  time numerical or algebraic **or** area under graph clear [C1]  
 $1.2 \times 3$  **or** 3.6 (m) **or**  $2.4 \times 5$  **or** 12 seen [C1]  
 15.6 m **or** 16 m [A1]
- (e) (i) mgh seen in any algebraic or numerical form, e.g.  $30 \times 10 \times 1.6$  [C1]  
 480 J [A1]
- (ii) heat or thermal energy or sound produced  
**or work done** against friction/air resistance [B1]
- (f) at least two distances and corresponding times mentioned [C1]  
 how the **actual measurement** is made, e.g. (**any one from**)  
 • make mark on ground every second and **measure** distances  
 • note video position every sec and use a scale to **find** distances  
 • make mark on ground every meter and **measure / take** time as girl passes [A1]  
 how constant speed is proved using measurement, e.g. (**any one from**)  
 • same distance between each position for the same time interval  
 • same time interval for equal distances  
 •  $\Delta d / \Delta t$  constant **or** slope of distance-time graph constant [B1]
- [15]

## Example candidate response – grade A

- 9 A children's ride consists of a steel cable that runs between two posts of different heights, as shown in Fig. 9.1.

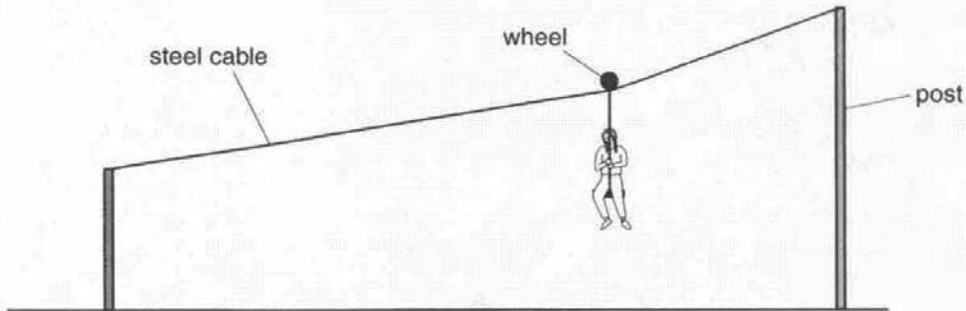

Fig. 9.1

A girl starts and finishes the ride at rest. Her horizontal motion can be taken as

- an initial uniform acceleration for 3.0 s, followed by
- a constant speed of 2.4 m/s for a further 5.0 s and
- a final uniform deceleration that lasts for 1.0 s.

- (a) On Fig. 9.2, draw a speed-time graph of the horizontal motion.

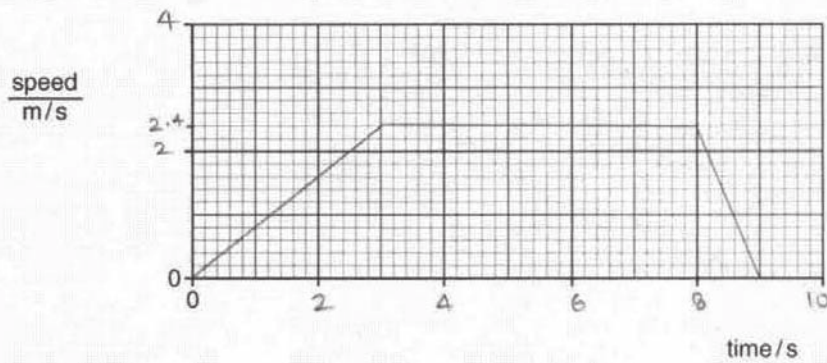

Fig. 9.2

[3]

- (b) Explain what is meant by *uniform acceleration*.

When the forward force is greater than the backward force and the velocity of the car is changing constantly with time. [2]



- (c) The final deceleration is larger in size than the initial acceleration.

Explain how the data shows this.

The ~~graph~~ gradient of the graph in deceleration is steeper which means it is larger. [1]

- (d) Calculate the horizontal distance travelled by the girl in the first 8.0 s.

$$\left( \frac{1}{2} \times 2.4 \times 3 \right) + 5 \times 2.4$$

$$3.6 + 12$$

distance = ..... 15.6 m ..... [3]

- (e) (i) The girl has a mass of 30 kg and falls a vertical distance of 1.6 m during the ride.

The gravitational field strength  $g$  is 10 N/kg.

Calculate the decrease in gravitational potential energy of the girl.

$$g.p.e = mgh$$

$$30 \times 10 \times 1.6$$

decrease in potential energy = ..... 480 J ..... [2]

- (ii) The gain in kinetic energy of the girl is less than the decrease in her potential energy. Suggest one reason for this.

The decrease in the potential energy is less as some energy is lost as heat. [1]

- (f) A group of pupils make measurements to show that the girl's speed is constant during the middle section of the ride.

Suggest what measurements are made and how they show that the speed is constant.

One student marks the distance of the middle section using tape measure. The other student marks the time of her ride during the middle section using a stop watch. They take out her speed using the equation  $speed = \frac{distance}{time}$ . Her speed is recorded which when showing does not change in middle section means constant speed. [3]

## Examiner comment – grade A

- (a) The graph drawn has used the data in the question correctly. The axes contained sensible numbers and the value at 2.4 m/s was plotted correctly. A common mistake was to plot this point as 2.8 m/s. The graph has an initial straight line portion and the final deceleration is uniform. The line drawn is neat and has been drawn using a ruler. Full marks were awarded. (3/3)
- (b) The initial statement about forces was ignored as it is a correct statement but does not answer the question, which asks ‘what is meant by uniform acceleration’ and not how it is produced. The second sentence was awarded only one mark as there is an indication that there is a constant change in velocity. However it is not clear that there is the same change in velocity per unit time as a car whose ‘velocity is changing constantly with time’ may be speeding up and slowing down all the time and not necessarily having the same change in speed per second. (1/2)
- (c) Although the candidate does not compare the gradient of the graph during the acceleration and deceleration sections explicitly, it is clear that the correct comparison is being made and the mark was awarded. (1/1)
- (d) The correct calculation and result has been produced in this answer, by dividing the motion into two sections. The formulae themselves were not given and it is advisable to give the actual formulae used before inserting the numerical values. However it is clear that the correct formulae have been used and the answer and unit are correct, so full marks were earned. (3/3)
- (e) In this section the calculation shown in (i) was excellent. The formula was stated with a left-hand side (g.p.e.) as well as a right-hand side (mgh). Numbers were inserted and the final answer was given the correct unit for energy. If the candidate had made any simple mistake, such as an arithmetic mistake, then, as the working is so clear, then as much credit as possible would have been given. In (ii) the candidate has correctly identified that this question is asking where the missing energy has gone. Many candidates gave more detail such as a description of the friction that caused the apparent loss in energy but the answer provided here was sufficient to be awarded the final mark. (3/3)
- (f) To show that the speed is constant in the middle section, at least two distances and their corresponding times need to be measured. This answer only seemed to measure one distance, the “distance of the middle section” and thus only one speed could be measured. Had the candidate suggested that the middle section was divided into parts and the time for each part was measured, then the answer would have been much improved. It was also not clear whether a distance was actually measured as the tape measure was just used to “mark the distance of the middle section”. A little more detail about marking made on the ground or the cable at specific distances or times with the use of a tape measure would have allowed the second mark to be scored. As the measurements were not clear, the experiment did not seem to show that several speeds would be found to be equal, and the third mark was not earned, even for the statement  $\text{speed} = \text{distance}/\text{time}$ . (0/3)

**Total mark awarded = 11 out of 15**



## Example candidate response – grade C

- 9 A children's ride consists of a steel cable that runs between two posts of different heights, as shown in Fig. 9.1.

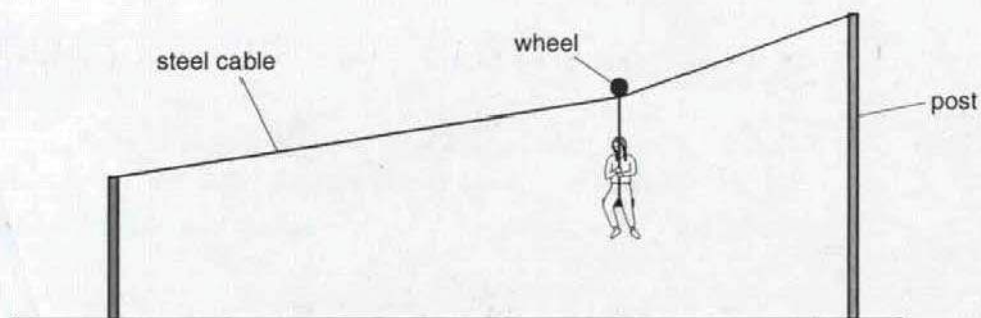

Fig. 9.1

A girl starts and finishes the ride at rest. Her horizontal motion can be taken as

- an initial uniform acceleration for 3.0 s, followed by
- a constant speed of 2.4 m/s for a further 5.0 s and
- a final uniform deceleration that lasts for 1.0 s.

- (a) On Fig. 9.2, draw a speed-time graph of the horizontal motion.

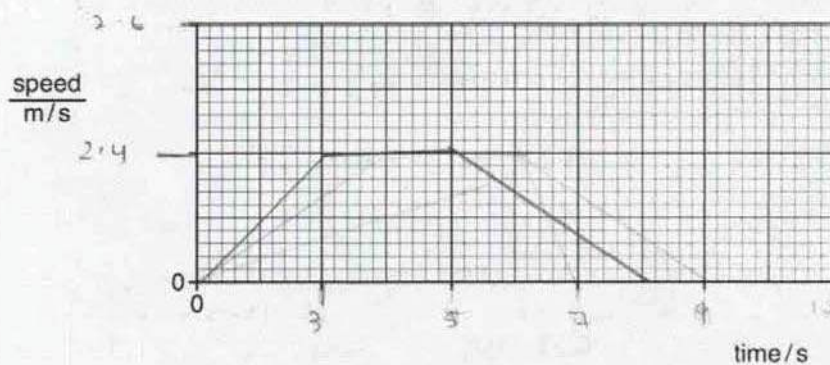

Fig. 9.2

[3]

- (b) Explain what is meant by *uniform acceleration*.

Uniform acceleration is that object is moving with constant velocity whereas moving with same speed respectively.

[2]

(c) The final deceleration is larger in size than the initial acceleration.

Explain how the data shows this.

uniform acceleration takes place than constant velocity at the mid then a retardation in one second. [1]

Calculate the horizontal distance travelled by the girl in the first 8.0 s.

$$s \text{ under the curve} = \frac{1}{2} \times (0 + 5) \times 2.4 \\ = 15.6$$

distance = 15.6 m [3]

The girl has a mass of 30 kg and falls a vertical distance of 1.6 m during the ride.

The gravitational field strength  $g$  is 10 N/kg.

Calculate the decrease in gravitational potential energy of the girl.

$$E_p = mgh \\ = 30 \times 10 \times 1.6$$

decrease in potential energy = 480 J [2]

The gain in kinetic energy of the girl is less than the decrease in her potential energy. Suggest one reason for this.

Because the girl is falling with greater energy so K.E increases and Potential energy is less. [1]

A group of pupils make measurements to show that the girl's speed is constant during the middle section of the ride.

Suggest what measurements are made and how they show that the speed is constant.

measuring the lengths of part of steel bar. the rope is also being measured by them. stop-watch should be used for the time taken place. Afterwards, the measured at the time is of an accurate graph. [3]

## Examiner comment – grade C

- (a)** Only the first section of the graph drawn was correct and, even then, including 2.6 on the speed axis makes this axis non-linear as 0, 2.4 and 2.6 m/s are equal distances apart on the y-axis. However it is clear that the initial acceleration phase is uniform and ends at (3,2.4) and so one mark was awarded. The general shape of the graph is correct with a straight line and a decelerating section, but the constant speed section ended at 5 s rather than lasting for 5 s and the final deceleration phase took 3 s, rather than the 1 s given in the question. (1/3)
- (b)** The answer confuses constant acceleration and constant velocity and does not indicate what is meant by acceleration at all, and so no mark can be awarded. (0/2)
- (c)** No comparison of the deceleration and acceleration has been made. Had the candidate suggested that the acceleration took 3 s as well as stating that the deceleration takes 1 s then the answer would have made a correct comparison. (0/1)
- (d)** The calculation was very good. A correct formula was used and it was clear that the area under the graph was calculated using a formula for a trapezium. Full marks were earned. (3/3)
- (e)** The formula was again given well in **(i)** and the left-hand side of the equation,  $E_p$ , is a good symbol to use for potential energy, in this case for gravitational potential energy. Full marks were earned. The answer to **(ii)** does not explain why the increase in K.E. is less than the decrease in P.E. and seems to suggest that total energy is increasing as the girl falls. No mark was earned for **(ii)**. (2/3)
- (f)** No sensible measurements of at least two distances and times were made and the measurements could not have been used to show that the speed was constant in part of the ride. (0/3)

**Total mark awarded = 6 out of 15**

## Example candidate response – grade E

- 9 A children's ride consists of a steel cable that runs between two posts of different heights, as shown in Fig. 9.1.

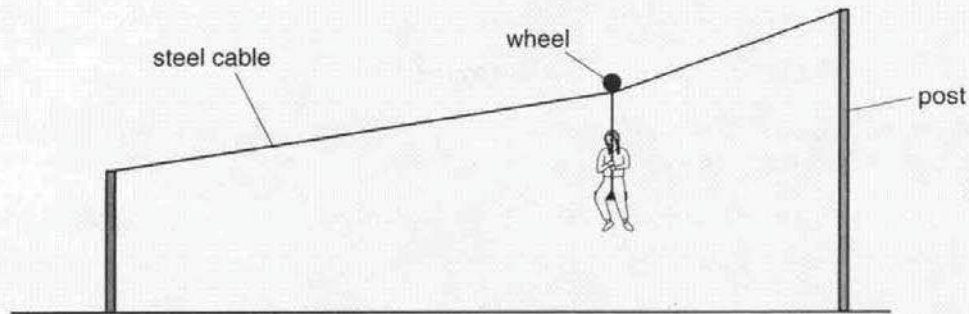

Fig. 9.1

A girl starts and finishes the ride at rest. Her horizontal motion can be taken as

- an initial uniform acceleration for 3.0 s, followed by
- a constant speed of 2.4 m/s for a further 5.0 s and
- a final uniform deceleration that lasts for 1.0 s.

- (a) On Fig. 9.2, draw a speed-time graph of the horizontal motion.

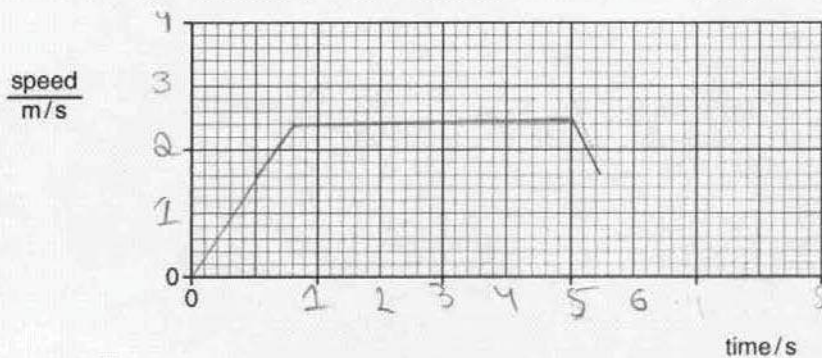

Fig. 9.2

[3]

- (b) Explain what is meant by *uniform acceleration*.

Uniform acceleration means that sudden change in speed that is happening in an uniform or constant rate.

[2]



- (c) The final deceleration is larger in size than the initial acceleration.

Explain how the data shows this.

By looking at the time and the length of the graph. [1]

- (d) Calculate the horizontal distance travelled by the girl in the first 8.0 s.

distance = 2 m. [3]

- (e) (i) The girl has a mass of 30 kg and falls a vertical distance of 1.6 m during the ride.

The gravitational field strength  $g$  is 10 N/kg.

Calculate the decrease in gravitational potential energy of the girl.

decrease in potential energy = 480 J [2]

- (ii) The gain in kinetic energy of the girl is less than the decrease in her potential energy. Suggest one reason for this.

It is due to her loss of movement that made her kinetic energy <sup>gain</sup> decrease less. [1]

- (f) A group of pupils make measurements to show that the girl's speed is constant during the middle section of the ride.

Suggest what measurements are made and how they show that the speed is constant.

A group of pupils can make measurements by using a stop watch and by taking the readings of the runs that the girl does for the mean time and by checking the speed and distance of the two parts. [3]

## Examiner comment – grade E

- (a) There was an attempt in this answer to draw an initial straight line on the speed-time graph and a further horizontal portion. However the values plotted on the time axis were wrong for each section, the initial acceleration lasting for less than one second and the constant speed section being less than 5 s. The time axis was non-linear with two squares representing the first second and then 2 seconds thereafter. This meant that no mark was earned. (0/3)
- (b) Although not well expressed, uniform acceleration is clearly defined as constant change in speed for the first mark and the idea that the speed increases at a constant rate introduces the idea that the increase is constant with respect to time and so two marks were awarded. (2/2)
- (c) The candidate mentions that the graph should be used but does not say how. Had he compared the steepness of the initial and final accelerations then a mark could have been awarded. (0/1)
- (d) The answer provided is wrong and there is no working shown and so no credit could be given for this answer. If the candidate had even provided a simple formula such as  $\text{speed} = \text{distance} / \text{time}$  then a mark would have been awarded. It is always sensible to show working and give an initial formula. (0/3)
- (e) The answer provided is correct in (i) and so full marks were awarded, even without the formula or working, although it is advisable to provide working. The statement in (ii) does not explain the difference between the two values for energy and shows no understanding of the conservation of energy and different types of energy. (2/3)
- (f) The candidate does not provide any detail about the measurements that were made. It would not be possible to follow the directions given in the answer to obtain a speed or show that the speed was constant. It would be helpful if, when describing an experiment, candidates provide a logical list of the readings to be taken, how they are taken and then how they are used to calculate the result or in this case to show that the speed is constant in the middle section. (0/3)

**Total mark awarded = 4 out of 15**



## Question 10

## Mark scheme

- 10 (a) (i) (conduction occurs) through or in metal/pan **or** from water to metal/pan  
**or** molecules vibrate **or** molecules collide  
**or** (free) electrons (in metal) move [B1]
- vibration/energy/heat passed **from molecule to molecule** clear  
**or** energy passed on by electrons colliding (with atoms/molecules or electrons) [B1]
- (ii) hot air or air over water rises or hot water rises [B1]  
hot air or hot water expands **or** hot air or water less dense [B1]
- (b) (i) black objects radiate heat more (than white) [B1]
- (ii) (both) graphs higher (after start)  
**or** temperature falls less (in same time)/slower  
**or** takes longer to cool [B1]
- less **evaporation** occurs **or** less **convection** [B1]
- (c) (i) heat/energy to change the temperature by  $1^{\circ}\text{C}$ /unit temp [C1]  
heat/energy to change the temperature of  $1\text{ kg}$ /unit mass by  $1^{\circ}\text{C}$ /unit temp [A1]
- (ii) long time to warm/boil water/cook  
**or** scalds/burns when touched  
**or** more energy needed (to warm water) [B1]
- (iii) 1.  $34(^{\circ}\text{C})$  **or**  $94-60$  seen [C1]  
(m=)  $Q/c\Delta T$  algebraic or numerical with any clear  $Q$  or  $\Delta T$  [C1]  
 $0.5(042)\text{ kg}$  [A1]
2.  $0.50 \times 4200 \times 54$  [C1]  
 $110\ 000$  **or**  $114(353)\text{ J}$  [A1]
- [15]

## Example candidate response – grade A

- 10 Two metal saucepans contain the same mass of hot water at the same initial temperature. Pan A is white and pan B is black, but otherwise the two saucepans are identical. Both saucepans are uncovered and cool under the same conditions. The cooling curves for the two saucepans are shown in Fig. 10.1.

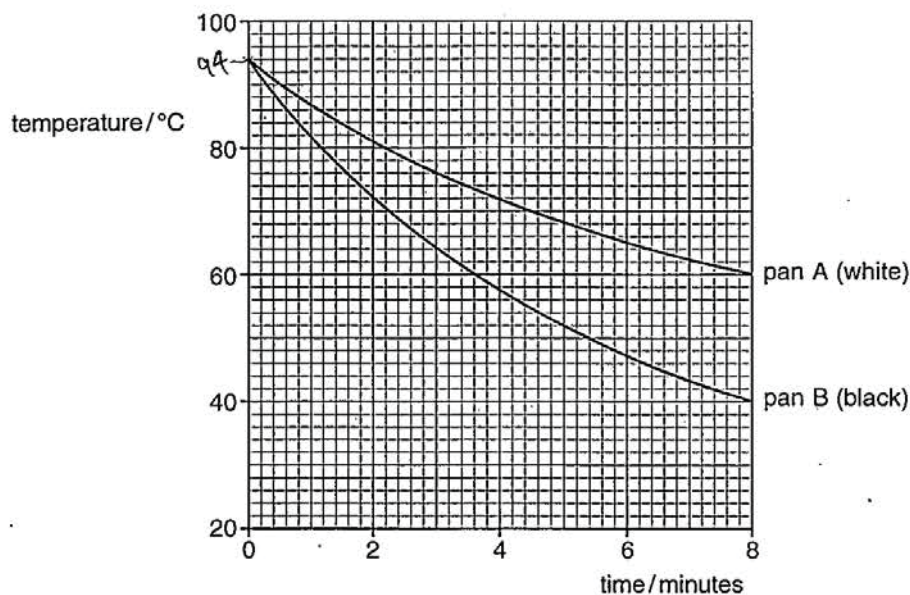

Fig. 10.1

- (a) Describe how the water in a pan loses heat by

- (i) conduction,

Conduction takes place in the metal. The vibrating particles in the solid metal lose their energy to the neighbouring particles due to collisions and the pan loses heat. [2]

- (ii) convection.

When hot water comes in contact with air. It loses its energy to air which becomes hot, less dense and rises. Cold air replaces it. The process continues and water loses heat. [2]

- (b) (i) Explain why pan B cools faster than pan A.

As black is a better emitter of heat, it cools faster. [1]

- (ii) Describe and explain how Fig. 10.1 is different when the pans are covered and the experiment is repeated.

When the pans are covered and experiment repeated, Pan B loses heat slowly than A, so the graph will be opposite as black surfaces are good absorbers, heat remain inside. [2]

- (c) The specific heat capacity of water is  $4200 \text{ J}/(\text{kg}^\circ\text{C})$ .

- (i) Explain what is meant by *specific heat capacity*.

It means the amount of thermal energy required to change the temperature of one unit mass by a temperature of  $1^\circ\text{C}$ . [2]

- (ii) The specific heat capacity of water is very high. Suggest one disadvantage of this when water is used for cooking.

A lot of water takes very long time to boil due to which food may not be cooked on time. [1]

- (iii) The water in pan A cools for 8 minutes, as shown in Fig. 10.1. During this time, the water loses an average of  $9000 \text{ J}$  of thermal energy per minute.

1. Calculate the mass of water in pan A.

$$\begin{aligned}
 e &= mc\Delta\theta \\
 m &= \frac{e}{c\Delta\theta} \\
 m &= \frac{9000}{4200(94-60)} \\
 m &= \frac{90000}{142800} \\
 \text{mass} &= \dots\dots\dots 0.063 \text{ kg} \dots\dots\dots [3]
 \end{aligned}$$

2. The mass of water in pan B is the same as that in pan A.

Calculate the thermal energy lost from the water in pan B during the 8 minutes.

$$\begin{aligned}
 e &= mc\Delta\theta \\
 e &= 0.063 \times 4200 \times 54
 \end{aligned}$$

$$\text{loss of thermal energy} = \dots\dots\dots 14288.4 \text{ J} \dots\dots\dots [2]$$

## Examiner comment – grade A

- (a)** The candidate has produced a well-reasoned argument in **(i)** that explains the molecular nature of conduction, in which molecular collisions pass on energy from one particle to the next. It is also clear that this energy is being conducted through the metal pan. In reality, much of the conduction within a metal will be due to electron movement but this molecular explanation was accepted for full marks. The explanation in **(ii)** shows a good understanding of convection and realises that it is convection in the air that takes heat away from the hot water. Many answers described convection in the water itself, which was also accepted as it is part of the process. This answer also clearly explains that the air, when heated, expands and becomes less dense and the answer does not rely on molecular explanations; such explanations that state that a molecule itself becomes less dense when heated may not be accepted. (4/4)
- (b)** The answer in **(i)** merely states that black is a good emitter of heat, and the mechanism of the heat loss was not stated. The answer would be improved by stating that black surfaces are better emitters of infra-red radiation or radiate heat better than white surfaces. In **(ii)** the candidate has decided that, when covered, the black surface cools faster than the white surface, whereas the obvious difference, in the actual graphs, is that both pans will cool slower than in the original experiment. There is no physical explanation provided for the candidate's assumption that, when covered, black surfaces emit less heat than white surfaces. (0/3)
- (c)** The definition provided in **(i)** was accepted for full marks. There is, in this answer, a mixture of statements, such as "unit mass" rather than 1 kg and '1°C' rather than "unit temperature rise". Either of these different forms or a mixture was accepted. In **(ii)** a sensible practical occurrence was described when it was suggested that water will take a long time to boil. The extra detail, that food may not be cooked on time, was not necessary, but shows that the candidate was considering the practical situation and was not just relying on knowledge of a definition. The calculation in **(iii)** 1. was set out very well with a formula and with numbers taken from the graph clearly set out. The only error was not to realise that the total energy supplied is  $8 \times 9000$  and not 9000 alone. Because the calculation was set out so clearly, only one mark was lost for the omission of the factor 8. The value of the mass calculated in **(iii)** 1. was used in **(iii)** 2. to calculate the loss in thermal energy. Full marks can be scored in a section that relies on numbers calculated in an earlier section and so this answer scored full marks. The answer is quoted to far more significant figures than can be justified by the data in the question or by the numbers read from the graph, but there was no penalty exacted. (7/8)

**Total mark awarded = 11 out of 15**



## Example candidate response – grade C

- 10 Two metal saucepans contain the same mass of hot water at the same initial temperature. Pan A is white and pan B is black, but otherwise the two saucepans are identical. Both saucepans are uncovered and cool under the same conditions. The cooling curves for the two saucepans are shown in Fig. 10.1.

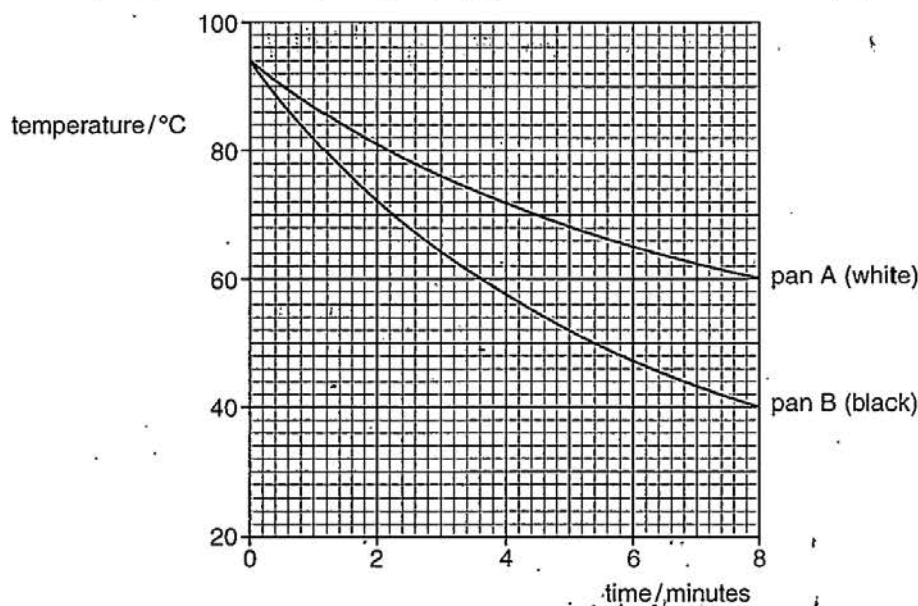

Fig. 10.1

- (a) Describe how the water in a pan loses heat by

- (i) conduction,

conduction is way of heat travelling. In this heat is travel by through the vibration of molecule. As the molecules vibrate, they collide, kinetic energy increases as a result loss of heat in water. [2]

- (ii) convection.

In convection heat is transmitted from a place to another through the movement of molecules. As the molecules get heat, they become less dense & rise in their place denser molecules comes. Process. [2]

- (b) (i) Explain why pan B cools faster than pan A.

Pan B cools faster due to radiation. As dull, black surfaces are the good absorber of radiation. [1]

- (ii) Describe and explain how Fig. 10.1 is different when the pans are covered and the experiment is repeated.

When pans will be covered then the radiating loss of heat will be less in pan A and pan B as the cover part will create hindrance and in pan B the temp will increase <sup>as more heat will be absorbed</sup> more.

- (c) The specific heat capacity of water is  $4200 \text{ J}/(\text{kg } ^\circ\text{C})$ .

- (i) Explain what is meant by *specific heat capacity*.

Amount of heat energy required to raise the temperature of  $1 \text{ kg}$  of a substance to  $1 \text{ K}$ . It is measured in  $\text{J.K}^{-1}\text{kg}^{-1}$  or  $\text{Joule per Kelvin}$ . [2]

- (ii) The specific heat capacity of water is very high. Suggest one disadvantage of this when water is used for cooking.

It will boil more quickly and the rest of food will be uncook. [1]

- (iii) The water in pan A cools for  $8$  minutes, as shown in Fig. 10.1. During this time, the water loses an average of  $9000 \text{ J}$  of thermal energy per minute.

1. Calculate the mass of water in pan A.

$$Q = mc\Delta\theta$$

$$9000 = m \times 4200 \times 8$$

$$9000 = m \times 33600$$

$$\frac{9000}{33600} = m$$

$$m = 0.2678$$

mass = ~~0.2678~~  $0.267$  [3]

2. The mass of water in pan B is the same as that in pan A.

Calculate the thermal energy lost from the water in pan B during the  $8$  minutes.

$$Q = mc\Delta\theta$$

$$Q = 0.2678 \times 4200 \times 8$$

$$Q = 9008.736$$

loss of thermal energy =  $9008.736$  [2]



## Examiner comment – grade C

- (a)** In **(i)**, the answer clearly describes the vibration and collision of the molecules but it is not clear that energy is passed on from one molecule to the next during such a collision and so only one mark was scored in **(i)**. It was also not clear whether the molecules involved were in the water or in the metal and it is helpful for candidates to apply descriptions to the actual situation involved in the question. Similarly, and more importantly, in **(ii)** it is not clear whether the molecules involved in the convection of heat are in the water or in the air and this is not a full answer and also only scored one mark. (2/4)
- (b)** In **(i)**, the candidate has stated that black is a good absorber of radiation. Whilst true, the question is about the emission and not the absorption of heat. More thought about the question and more experience with practical situations might have helped the candidate to realise the difference between these two processes. In **(ii)**, the question asks for a description and an explanation. The candidate finishes with a partial attempt at a description by stating that the temperature in pan B “will increase more”. Had the answer stated that the final temperature in pan B is higher than in the original experiment this would be accepted but this answer clearly suggests that the temperature in pan B has been rising and not falling and this was not accepted. The answer starts with an explanation that covered pans radiate less heat but the major reason is that less heat is lost by convection or evaporation and this explanation was not given a mark. (0/3)
- (c)** The definition was given full marks in **(i)**. The temperature rise was quoted as  $1\text{K}^\circ$  rather than just  $1\text{K}$  but this was accepted. Candidates should be careful, however, to quote temperatures as, for example,  $10^\circ\text{C}$  rather than  $10\text{C}^\circ$ . The unit quoted for specific heat capacity was incorrect but this detail was not asked and was not considered to contradict the definition. In **(ii)** the candidate has wrongly stated that the water will boil more quickly. In **(iii)** the first mark was awarded for the formula but it appears that the time quoted was taken as the rise in temperature and so no further marks were given. No unit was given for the answer and the answer was rounded incorrectly from 0.2678 to 0.267; candidates should always give a final unit in a calculation and attempt to round correctly. The same types of error occurred in **(iii)** and there was also an arithmetical mistake in the final calculation. (3/8)

**Total mark awarded = 5 out of 15**

## Example candidate response – grade E

- 10 Two metal saucepans contain the same mass of hot water at the same initial temperature. Pan A is white and pan B is black, but otherwise the two saucepans are identical. Both saucepans are uncovered and cool under the same conditions. The cooling curves for the two saucepans are shown in Fig. 10.1.

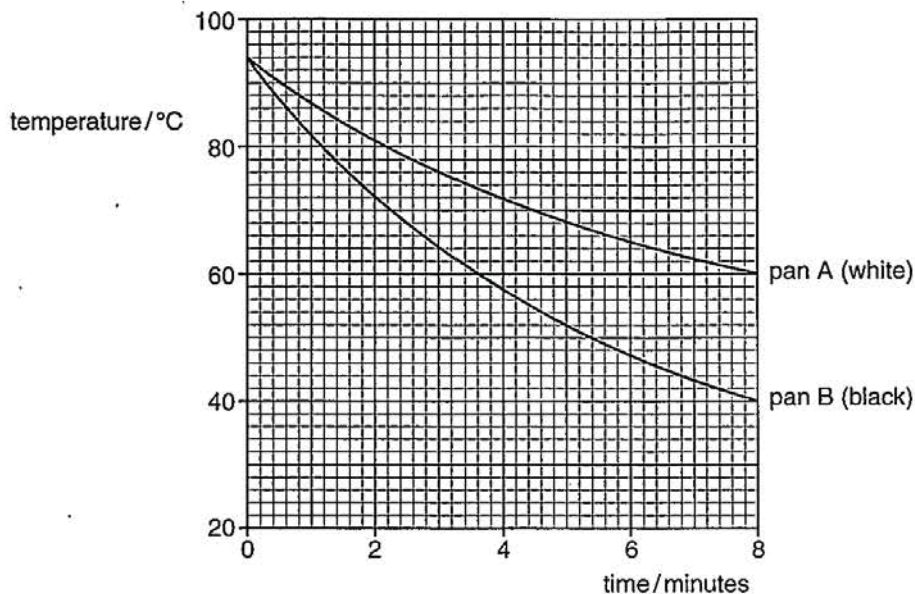

Fig. 10.1

- (a) Describe how the water in a pan loses heat by

- (i) conduction,

The water in a pan loses heat by conduction. The heat energy of the water molecules is absorbed by the wall of saucepan and escapes in the surrounding [2]

- (ii) convection.

The water in a pan loses heat by convection. Convection currents are set in water due to difference in densities at various parts in water. Heat is lost due to convection currents. [2]

- (b) (i) Explain why pan B cools faster than pan A.

Pan B cools faster because it is black and black colour emits more heat as compared to white. [1]

- (ii) Describe and explain how Fig. 10.1 is different when the pans are covered and the experiment is repeated.

As the pans would be covered, heat is <sup>not</sup> lost to the surroundings. Pan A will cool faster because <sup>as</sup> Pan B is covered ~~with~~ it will absorb more heat and its temp. will increase. [2]

- (c) The specific heat capacity of water is  $4200 \text{ J/(kg}^\circ\text{C)}$ .

- (i) Explain what is meant by *specific heat capacity*.

The amount of heat energy required to raise the temp of  $1 \text{ kg}$  of a substance by  $1^\circ\text{C}$  is known as specific heat capacity. Its unit is  $\text{J/kg}^\circ\text{C}$  and symbol is  $c$ . [2]

- (ii) The specific heat capacity of water is very high. Suggest one disadvantage of this when water is used for cooking.

It boils very vigorously causing harm to the surrounding. [1]

- (iii) The water in pan A cools for 8 minutes, as shown in Fig. 10.1. During this time, the water loses an average of  $9000 \text{ J}$  of thermal energy per minute.

1. Calculate the mass of water in pan A.

cools for 8 mins	cools for 8 mins
$9000 \text{ J/min}$	$9000 \text{ J/min}$
$9000 \times 8$	$= 72000 \text{ J}$
$72000$	

$\text{mass} = \frac{72000}{1000}$   
 $= 72 \text{ kg}$   
 $\text{mass} = 72 \text{ g}$  [3]

2. The mass of water in pan B is the same as that in pan A.

Calculate the thermal energy lost from the water in pan B during the 8 minutes.

$E = \text{Energy dissipated} = I^2 R T$

8 mins	Energy Lost By Pan A - Pan B $72000 - 56000$ $16000 \text{ J}$
$7000 \text{ J} \times 8$	
$56000 \text{ J}$	

loss of thermal energy =  $16000 \text{ J}$  [2]

## Examiner comment – grade E

- (a) The answer in (i) clearly indicates that heat is absorbed by the wall of the saucepan and this was taken as a description of conduction through the metal pan and awarded the first mark. There was no further description of the process and candidates, when answering a question worth two marks, should give more than the simple detail that is present in this answer.

The answer in (ii) starts by repeating the question which does not earn any credit and reduces the space for the actual answer. A difference in densities was mentioned but this was not sufficient as the particular difference in densities was required. The question asks for a description and this should involve, in this case, what might be observed to happen. (1/4)

- (b) The answer in (i) needed to mention radiation or infra-red, rather than just black emits more heat. The answer in (ii) wrongly suggested that pan A cools faster when covered. There was an attempt at an explanation by the statement that 'heat is not lost' but more detail was required, for example that there is less convection of heat or less evaporation. (0/3)
- (c) The definition in (i) was well expressed and earned full marks. The idea expressed in (ii) was incorrect and the candidate might have thought more carefully as to the real meaning of specific heat capacity. In the calculations in (iii) the formula was not quoted and neither was the graph used to find the difference in temperature and so no mark was awarded. (2/8)

**Total mark awarded = 3 out of 15**

## Question 11

## Mark scheme

11 (a)	ammeter and voltmeter correct symbols	[B1]
	ammeter in series with lamp	[B1]
	voltmeter in parallel with lamp	[B1]
(b)	R limits or reduces the current/voltage	[B1]
	otherwise lamp blows	
	<b>or</b> more of the $50\ \Omega$ can be used to adjust voltage/current	[B1]
(c) (i)	12V, 0.25A correctly plotted (by eye)	[B1]
	curved line from origin	[B1]
	correct curvature – decreasing slope	[B1]
(ii)	straight line (for fixed resistor)	[B1]
	<b>lamp</b> has changing temperature or changing resistance	
	<b>or</b> fixed resistor has constant temperature or constant <b>resistance</b>	[B1]
(d) (i)	$(I =) V/R$ in any algebraic or numerical form, e.g. $12/50$	[C1]
	0.24A	[A1]
(ii)	0.49A	[B1]
(iii)	6(.0)V	[B1]
(iv)	12(.24) $\Omega$	[B1]
		[15]



Example candidate response – grade A

11 A student sets up the circuit shown in Fig. 11.1.

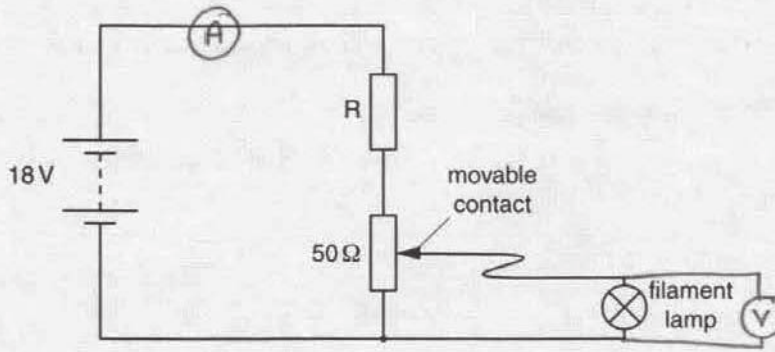

Fig. 11.1

R is a fixed resistor in the circuit. The filament lamp is marked 12V, 0.25A.

The circuit is used to produce a current/voltage graph for the filament lamp. The ammeter and voltmeter needed are not shown.

To obtain different readings, the student changes the position of the movable contact.

(a) On Fig. 11.1, draw the symbols for an ammeter and a voltmeter in the correct positions. [3]

(b) Explain why it is sensible to include the resistor R in this circuit.

To prevent the large amount of current than the requirement of filament lamp is entering the lamp-

(c) (i) On Fig. 11.2, sketch a current/voltage graph for the lamp.

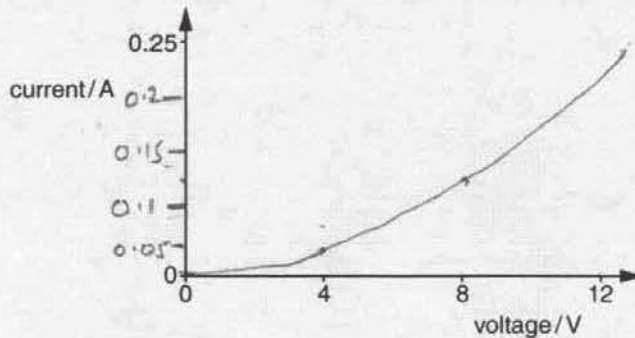

Fig. 11.2

[3]

- (ii) State and explain how a current/voltage graph for a fixed resistor is different from the graph for a filament lamp.

*It must be a straight line passing through origin - while the filament lamp shows a curve -*

..... [2]

- (d) Fig. 11.3 shows the position of the movable contact when the voltage across the lamp is 12V and the current in the lamp is 0.25 A.

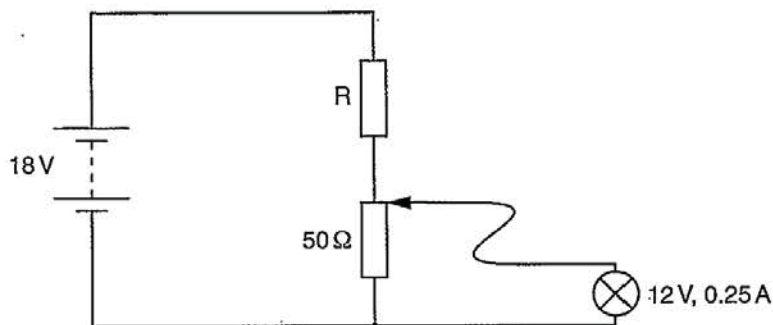

Fig. 11.3

Determine

- (i) the current in the 50Ω resistor,

$$V = IR$$

$$I = 12/50$$

current = ~~0.36 A~~ 0.24 A [2]

- (ii) the current in R,

$$V = IR$$

$$I = 12/50$$

current = ~~0.36 A~~ 0.24 A [1]

- (iii) the potential difference (p.d.) across R,

p.d. = 6 V [1]

- (iv) the resistance of R.

resistance = ~~16.7~~ 25 Ω [1]

## Examiner comment – grade A

- (a)** The correct circuit symbols for an ammeter and voltmeter were both shown and the voltmeter was correctly placed across the lamp. However the ammeter does not measure the current in the lamp itself and so only two marks were awarded. (2/3)
- (b)** The candidate sensibly suggested that the resistor reduces the current in the lamp but a little more detail was required for full marks, for example why it is necessary not to exceed the lamp rating. Really good answers suggested that the resistor limits the maximum voltage that can be placed across the lamp or that all of the variable resistor can then be used to make adjustments, rather than only 2/3rds. (1/2)
- (c)** The graph drawn in **(i)** earned two marks for showing a point that was taken as (12,0.25) and being curved. The graph however curves in the wrong direction and would involve a decrease in resistance with an increase in temperature. In **(ii)**, there was a statement as to how the graphs differ, one being curved and the other not but there was no explanation and so only one mark was awarded. Candidates when asked in a question to state and explain should know the difference between these two command words and structure their answer accordingly. (3/5)
- (d)** In **(i)**, the correct formula was quoted and the correct values used. Many candidates incorrectly used 18 V as the p.d. across the lamp. In **(ii)**, the same answer was quoted as in **(i)**, whereas the current in the resistor R is the sum of the current in the  $50\Omega$  resistor and the current in the lamp. Other answer in **(iii)** and **(iv)** were correct given the error that had been made in **(ii)** and scored full marks. (4/5)

**Total mark awarded = 10 out of 15**

## Example candidate response – grade C

11 A student sets up the circuit shown in Fig. 11.1.

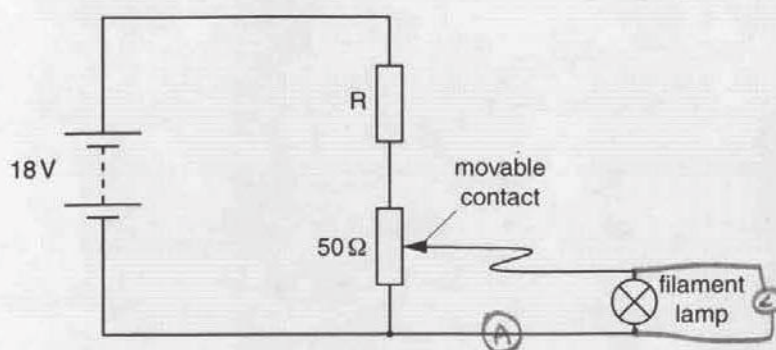

Fig. 11.1

R is a fixed resistor in the circuit. The filament lamp is marked 12V, 0.25A.

The circuit is used to produce a current/voltage graph for the filament lamp. The ammeter and voltmeter needed are not shown.

To obtain different readings, the student changes the position of the movable contact.

(a) On Fig. 11.1, draw the symbols for an ammeter and a voltmeter in the correct positions. [3]

(b) Explain why it is sensible to include the resistor R in this circuit.

*To measure the current and the voltage of the lamp more accurately.*

[2]

(c) (i) On Fig. 11.2, sketch a current/voltage graph for the lamp.

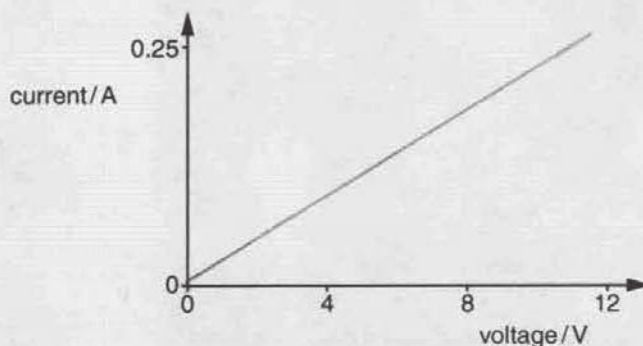

Fig. 11.2

[3]

- (ii) State and explain how a current/voltage graph for a fixed resistor is different from the graph for a filament lamp.

A fixed resistor's graph will be different because the mass in the resistor is fixed and doesn't change. [2]

- (d) Fig. 11.3 shows the position of the movable contact when the voltage across the lamp is 12V and the current in the lamp is 0.25 A.

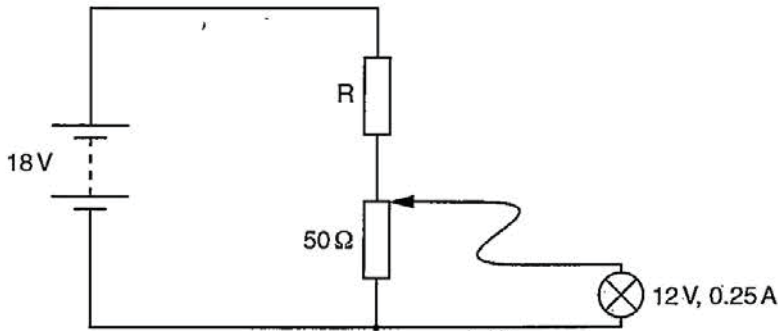

Fig. 11.3

Determine

- (i) the current in the 50Ω resistor,

$$V = IR$$

$$18 = I \times 50$$

$$I = \frac{18}{50} = I$$

current = 0.36 A [2]

- (ii) the current in R,

series circuit.

current = 0.36 A [1]

- (iii) the potential difference (p.d.) across R,

Series circuit.

p.d. = 18 V [1]

- (iv) the resistance of R.

$$V = IR$$

$$18 = 0.36 \times R$$

$$\frac{18}{0.36} = R$$

resistance = 50 Ω [1]



## Examiner comment – grade C

- (a)** The circuit symbols for both the ammeter and voltmeter were correct and both were in the correct place. The candidate clearly understands that these meters will be measuring the correct quantities for the lamp itself and full marks were awarded. (3/3)
- (b)** The explanation provided was not clear enough. Had the answer suggested that there would be a greater range of movement of the moveable contact to achieve 0 to 12V then credit would have been given but the resistor does not itself affect the accuracy of any reading on the meters; indeed it will reduce the current and decrease the percentage uncertainty in the reading. (0/2)
- (c)** The graph drawn in **(i)** was given one mark as it was taken to pass through the correct working p.d. and current for the lamp. It was not however curved, as it should be for a lamp and this affected the answer to **(ii)** which could not be given any credit. (1/5)
- (d)** The calculation in **(i)** uses the correct formula and was given the first mark but, unfortunately, the calculation uses the whole of the e.m.f. of the battery as being across the  $50\Omega$  resistor and so full marks were not earned. In **(ii)**, the same answer was quoted as in **(i)**, whereas the current in the resistor R is the sum of the current in the  $50\Omega$  resistor and the current in the lamp. The candidate needed to consider more carefully the p.d. across the various components in a series circuit as the full 18V cannot be across one component, as was stated in **(iii)**. The final calculation in **(iv)** correctly used the values obtained by the candidate in previous sections and was awarded the mark. (2/5)

**Total mark awarded = 6 out of 15**

Example candidate response – grade E

11 A student sets up the circuit shown in Fig. 11.1.

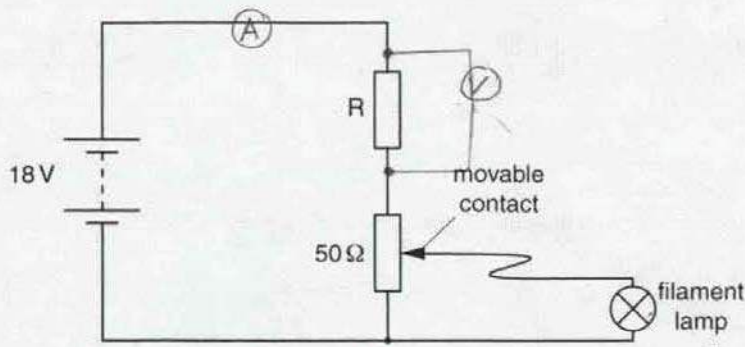

Fig. 11.1

R is a fixed resistor in the circuit. The filament lamp is marked 12V, 0.25A.

The circuit is used to produce a current/voltage graph for the filament lamp. The ammeter and voltmeter needed are not shown.

To obtain different readings, the student changes the position of the movable contact.

(a) On Fig. 11.1, draw the symbols for an ammeter and a voltmeter in the correct positions. [3]

(b) Explain why it is sensible to include the resistor R in this circuit.

*It will create a potential difference. To <sup>set a</sup> prevent any controlled amount of current to <sup>be set</sup> through the filament lamp.* [2]

(c) (i) On Fig. 11.2, sketch a current/voltage graph for the lamp.

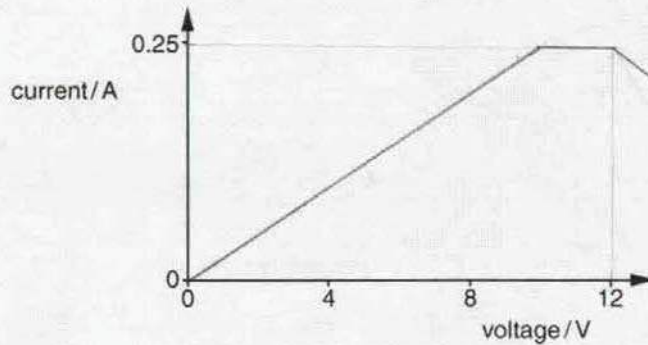

Fig. 11.2

[3]

- (ii) State and explain how a current/voltage graph for a fixed resistor is different from the graph for a filament lamp.

A fixed resistor obeys Ohm's law, the voltage is proportional to the current, but <sup>the</sup> filament lamp doesn't obey Ohm's law as it stops electron flow when heated and voltage flow when exceeded. [2]

- (d) Fig. 11.3 shows the position of the movable contact when the voltage across the lamp is 12V and the current in the lamp is 0.25 A.

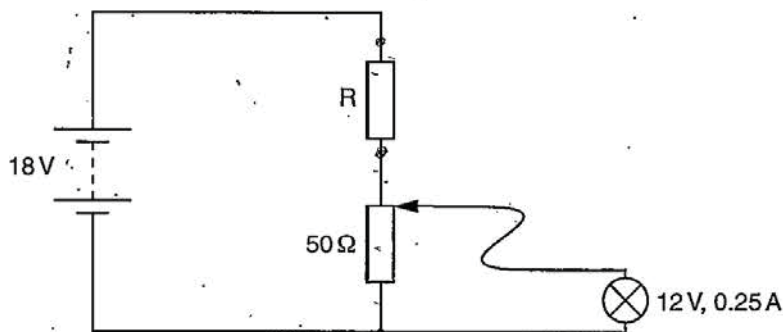

Fig. 11.3

$$\frac{1}{R} = \frac{1}{R_1} + \frac{1}{R_2}$$

Determine

- (i) the current in the 50 Ω resistor,

$$R = I \times V$$

$$R = R_1 + R_2$$

$$50\Omega = I \times 18V$$

$$I = \frac{50\Omega}{18V} = 2.7777$$

current = ~~2.8 A~~ 2.78 A [2]

- (ii) the current in R,

current = 3.03 A [1]

- (iii) the potential difference (p.d.) across R,

p.d. = 54.5 V [1]

- (iv) the resistance of R.

resistance = 54.5 Ω [1]

## Examiner comment – grade E

- (a)** One mark was awarded for both the correct circuit symbols for an ammeter and a voltmeter, but no more marks could be awarded as these meters were both in the wrong position. (1/3)
- (b)** The candidate made a suggestion along the correct lines, but the resistor R does not control the current in the lamp, it limits or reduces this current. Control of the current is undertaken by moving the contact on the  $50\ \Omega$  resistor. (0/2)
- (c)** The graph drawn in **(i)** was given one mark as it was taken to pass through the correct working p.d. and current for the lamp. It was not however curved correctly, being two straight lines; it was expected that any initial straight line would not continue past 10 V. Mentioning ohm's law in **(ii)** was not helpful, but it was clear that, for a fixed resistor, that current is proportional to voltage and this was taken as indicating that the fixed resistor should produce a straight line graph. The explanation of what happens in a filament lamp was not accepted as the rise in temperature at higher voltages was not clear and the description that electron flow is stopped or that voltage flows was unclear. (2/5)
- (d)** The formula used relating current, voltage and current was incorrect in **(i)**. It is sensible for candidates to start by writing down initially the formula that they are sure of and then rearranging it later, if necessary. No credit was earned from such a wrong start to the question. The candidate did however earn a mark in **(ii)** as the answer given was the sum of the value given in **(i)** and the current in the lamp. The working has not been shown but it appears that the candidate has understood that the current splits at the junction of the lamp and  $50\ \Omega$  resistor. The calculations in **(iii)** and **(iv)** had no working and were incorrect or had the wrong units. (1/5)

**Total mark awarded = 4 out of 15**

## Paper 4 Alternative to Practical

### Question 1

#### Mark scheme

- 1 (a) (i) correct length clearly marked [B1]
- (ii) **any one from** [B1]  
 rod moves in the water  
 does not float vertically  
 sides of the beaker obstruct  
 clear explanation of why parallax error occurs here
- (iii) Practical method stated, e.g. [C1]  
 1. mark water level on stick  
 2. mark scale on stick  
 3. **ruler** held in clamp/close to beaker/close to rod  
 4. length measured using a caliper
- Clear practical detail, e.g. [A1]  
 1. + remove and measure  
 2. + before placing in water/note water level  
 3. + view perpendicularly/subtract two readings  
 4. + depth measurer on caliper
- (b) (i) axes labelled quantity and unit [B1]  
 scales linear y-axis: 2 cm  $\equiv$  1 cm [B1]  
 x-axis: 2 cm  $\equiv$  2  
 points plotted accurately within  $\frac{1}{2}$  small square [B1]  
 best fit straight line drawn [B1]
- (ii) negative gradient/decreases as  $N$  increases inverse relationship [B1]  
 $\Delta N \propto \Delta l$  linear/straight line/constant gradient [B1]
- (iii) 11 [B1]
- (c) **any one from** [B1]  
 same mass/weight  
 mass/weight increases by same amount each time  
 fair test/fair comparison
- [12]



## Example candidate response – grade A

1 A student investigates a floating wooden rod.

The wooden rod is placed in a tall beaker. A rubber band around one end of the rod makes it float vertically, as shown in Fig. 1.1.

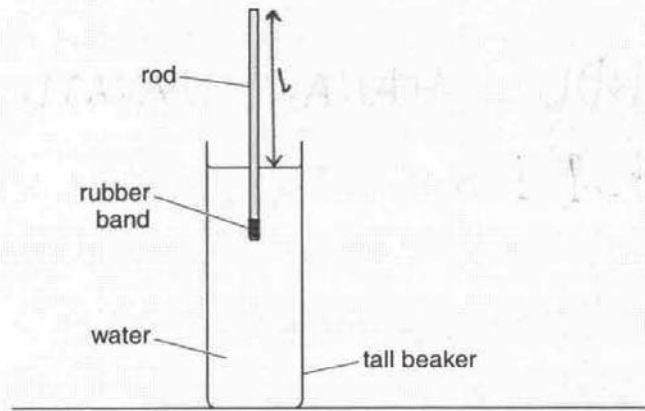

Fig. 1.1 (not to scale)

(a) (i) On Fig. 1.1, mark and label the length  $l$  of the rod above the water. [1]

(ii) Explain why it is difficult to measure  $l$ .

The walls of the container rise above sides of water level so rule difficult to place near rod as water may touch rule. [1]

(iii) Describe a method of measuring  $l$  accurately.

Use a rule and keep it as close as possible to side of beaker vertically. Keep line of sight perpendicular to scale of rule and measure from bottom of meniscus to top of rod, keeping eye as close as possible to rule. [2]

(b) The student increases the number  $N$  of rubber bands on the bottom of the rod and measures  $l$  for each value of  $N$ . Fig. 1.2 shows the student's results.

$N$	$l$ /cm
1	8.5
3	6.8
5	5.1
7	3.5
9	1.6

Fig. 1.2

- (i) On Fig. 1.3, plot the graph of  $l/\text{cm}$  on the  $y$ -axis against  $N$  on the  $x$ -axis. Start your graph from the origin. Draw the line of best fit.

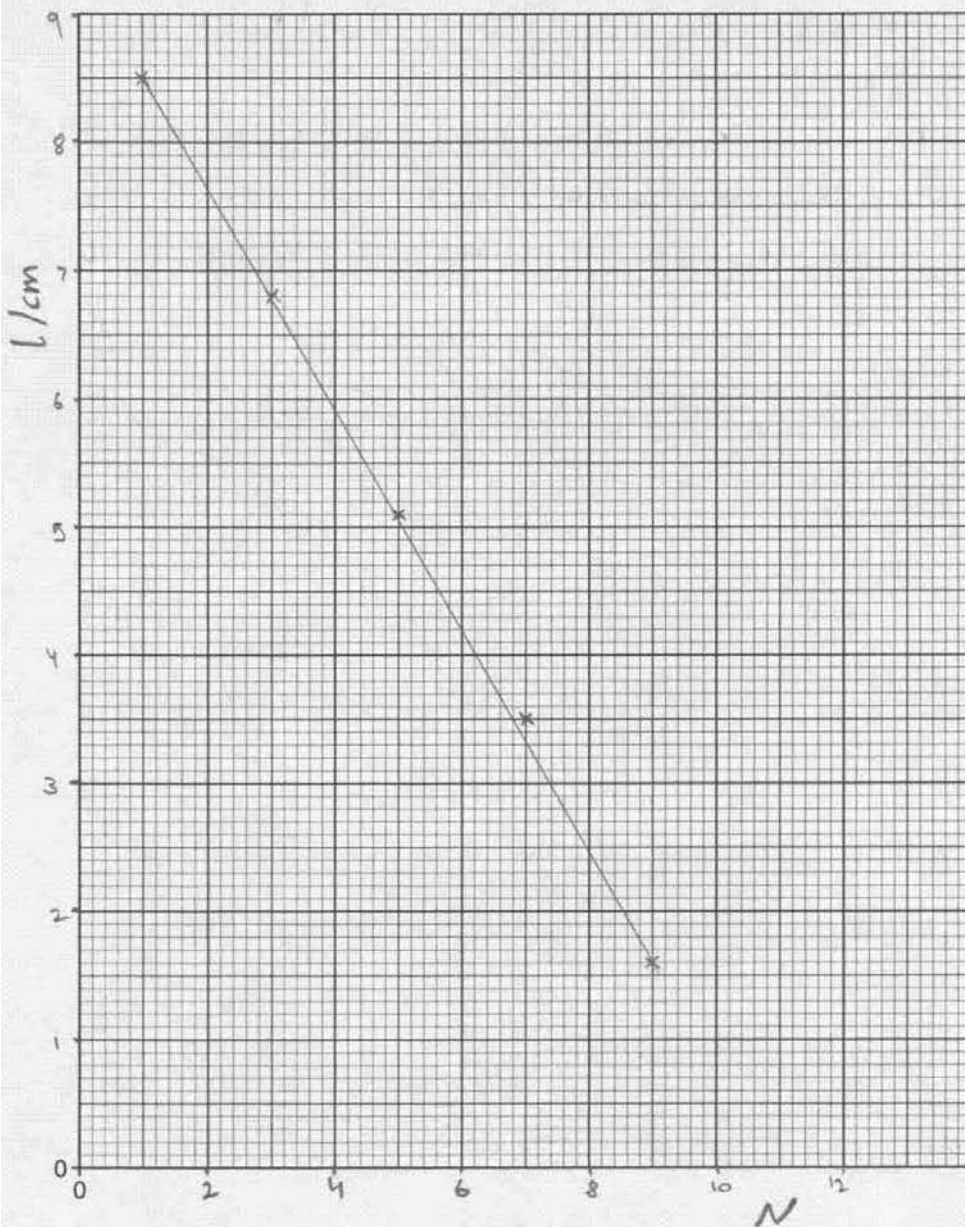

[4]

Fig. 1.3

- (ii) Describe the relationship between  $l$  and  $N$ .

As  $N$  increases  $l$  decreases. Linear graph.  
~~As  $N$  increases  $l$  decreases.~~  $l$  and  $N$  are inversely proportional. [2]

- (iii) Use the graph to estimate the smallest number of bands needed to sink the rod.

number of bands = .....11.....[1]

- (c) Explain why it is important to use identical rubber bands.

for accuracy as different rubber bands will have  
different weights/masses and will result to  
a different / non linear change in l.  
.....[1]

### Examiner comment – grade A

- (a) This candidate gave an excellent response to this question and scored full marks.

- (i) The length of the rod was clearly marked with one arrow just touching the water and the other at the same level as the top of the rod. It is advisable to use a sharp pencil when indicating a length as the examiner is looking for precision.
- (ii) An explanation of how the sides of the beaker obstruct the measurement was given.
- (iii) A practical method was explained with detail i.e. the ruler is held **close** to the beaker **and** the line of sight is perpendicular to the scale. There are two marks for the question and the candidate should be looking to make two valid points here. (4/4)

- (b) Full marks were scored for the graph – the axes are labelled correctly, a sensible and linear scale is used on both axes, points are plotted accurately within half a square and the line of best fit is acceptable. Again, a sharp pencil is advisable when plotting points and a precise cross is better than a dot as some dots are too big and lose the mark. The trend of the graph is fully and correctly described in part (ii) i.e. the graph was linear but not showing an inversely proportional relationship. Some candidates incorrectly stated that the relationship was inversely proportional and so they lost the second mark here. The candidate then correctly extrapolated his graph in (iii) to estimate the number of bands needed to sink the rod and also realised that his answer must be a whole number greater than the point at which his line met the x axis. (7/7)

- (c) The examiner is looking for the idea of a fair comparison here. Many candidates stated that the accuracy or the reliability of the experiment would be improved but this was not awarded a mark unless a further correct comment was made. This candidate explains that the identical rubber bands will have the same mass and does gain the mark. (1/1)

**Total mark awarded = 12 out of 12**



## Example candidate response – grade C

1 A student investigates a floating wooden rod.

The wooden rod is placed in a tall beaker. A rubber band around one end of the rod makes it float vertically, as shown in Fig. 1.1.

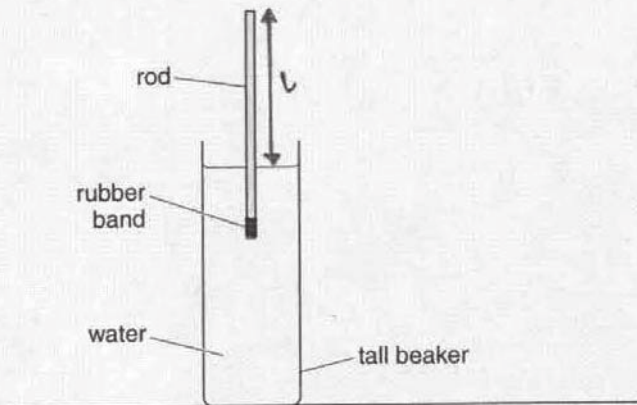

Fig. 1.1 (not to scale)

(a) (i) On Fig. 1.1, mark and label the length  $l$  of the rod above the water. [1]

(ii) Explain why it is difficult to measure  $l$ .

This is because the rod will easily bob up and down if we touch the water cylinder (due to water waves) <sup>causing a parallel error</sup>. [1]

(iii) Describe a method of measuring  $l$  accurately.

Place the rod in the water. Mark the end of the surface coming out of the water with a (waterproof) marker. Take out the rod and using a scale measure <sup>the</sup> ~~to~~ till <sup>mark</sup> marker. [2]

(b) The student increases the number  $N$  of rubber bands on the bottom of the rod and measures  $l$  for each value of  $N$ . Fig. 1.2 shows the student's results.

$N$	$l/\text{cm}$
1	8.5
3	6.8
5	5.1
7	3.5
9	1.6

Fig. 1.2

- (i) On Fig. 1.3, plot the graph of  $l/\text{cm}$  on the  $y$ -axis against  $N$  on the  $x$ -axis. Start your graph from the origin. Draw the line of best fit.

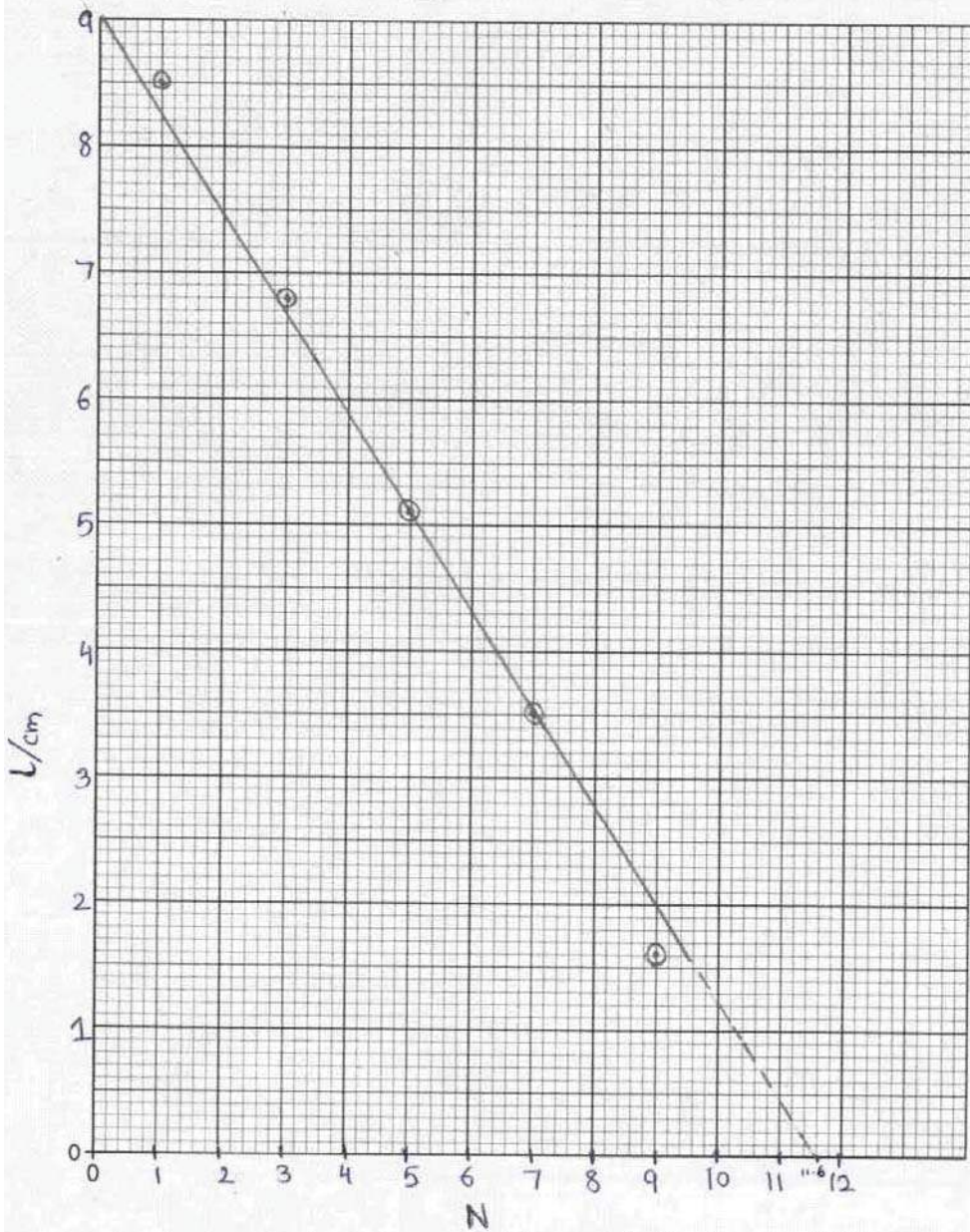

[4]

Fig. 1.3

- (ii) Describe the relationship between  $l$  and  $N$ .

*l is inversely proportional to N and the gradient of their graph is constant.*

[2]



(iii) Use the graph to estimate the smallest number of bands needed to sink the rod.

number of bands needed are  $11.6 \approx 12$

number of bands = .....12.....[1]

(c) Explain why it is important to use identical rubber bands.

It is important to use identical rubber bands in order to get an accurate (equal) reading. Different type of rubber bands may have different mass or volume which could affect the readings. [1]

### Examiner comment – grade C

(a) (i) The mark was not awarded here as the tip of the arrow is seen to be higher than the top of the rod.

(ii) The candidate has clearly explained that the movement of the rod will make it difficult to measure the length and the mark was awarded.

(iii) The candidate described a practical method of measuring  $l$  correctly and scored both marks. (3/4)

(b) This candidate scored three out of the four available marks for the graph. The axes are clearly labelled and a sensible, linear scale is used on both axes. The points are precisely plotted with small dots gaining the third mark. However, the line of best fit does not score the mark. The candidate should aim to draw his line as close to as many of the points as possible. Sometimes this may result in the line missing some points in which case, the line should aim to have as many points below as above it. However, in this case the line could be drawn to go through (or very close to) the majority of the points and this should have been done. One mark is awarded in part (ii) for describing the relationship as inversely proportional. This is not strictly correct and would have prevented the candidate gaining both marks if he had scored another correct marking point. However, it does show some understanding that one variable increases as the other decreases so it is given one mark. The candidate correctly extended his line in part (iii) to meet the x-axis and correctly recorded his answer as 12. This gained the mark (error carried forward). (5/7)

(c) The candidate stated that it is important to use identical bands to get an accurate reading. This is not enough to get the mark. However, he goes on to explain that different bands may have different masses and so gains the mark. (1/1)

**Total mark awarded = 9 out of 12**

## Example candidate response – grade E

1 A student investigates a floating wooden rod.

The wooden rod is placed in a tall beaker. A rubber band around one end of the rod makes it float vertically, as shown in Fig. 1.1.

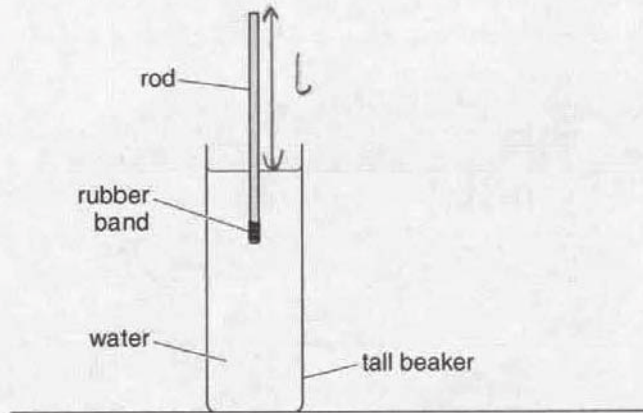

Fig. 1.1 (not to scale)

- (a) (i) On Fig. 1.1, mark and label the length  $l$  of the rod above the water. [1]  
 (ii) Explain why it is difficult to measure  $l$ .

It is due to parallax error as the ruler is cannot be placed as close as possible. [1]

- (iii) Describe a method of measuring  $l$  accurately.

By using a ruler vertically. Use two set squares align to the top end of the rod and just above the water. [2]

- (b) The student increases the number  $N$  of rubber bands on the bottom of the rod and measures  $l$  for each value of  $N$ . Fig. 1.2 shows the student's results.

$N$	$l/\text{cm}$
1	8.5
3	6.8
5	5.1
7	3.5
9	1.6

Fig. 1.2



- (i) On Fig. 1.3, plot the graph of  $l/\text{cm}$  on the  $y$ -axis against  $N$  on the  $x$ -axis. Start your graph from the origin. Draw the line of best fit.

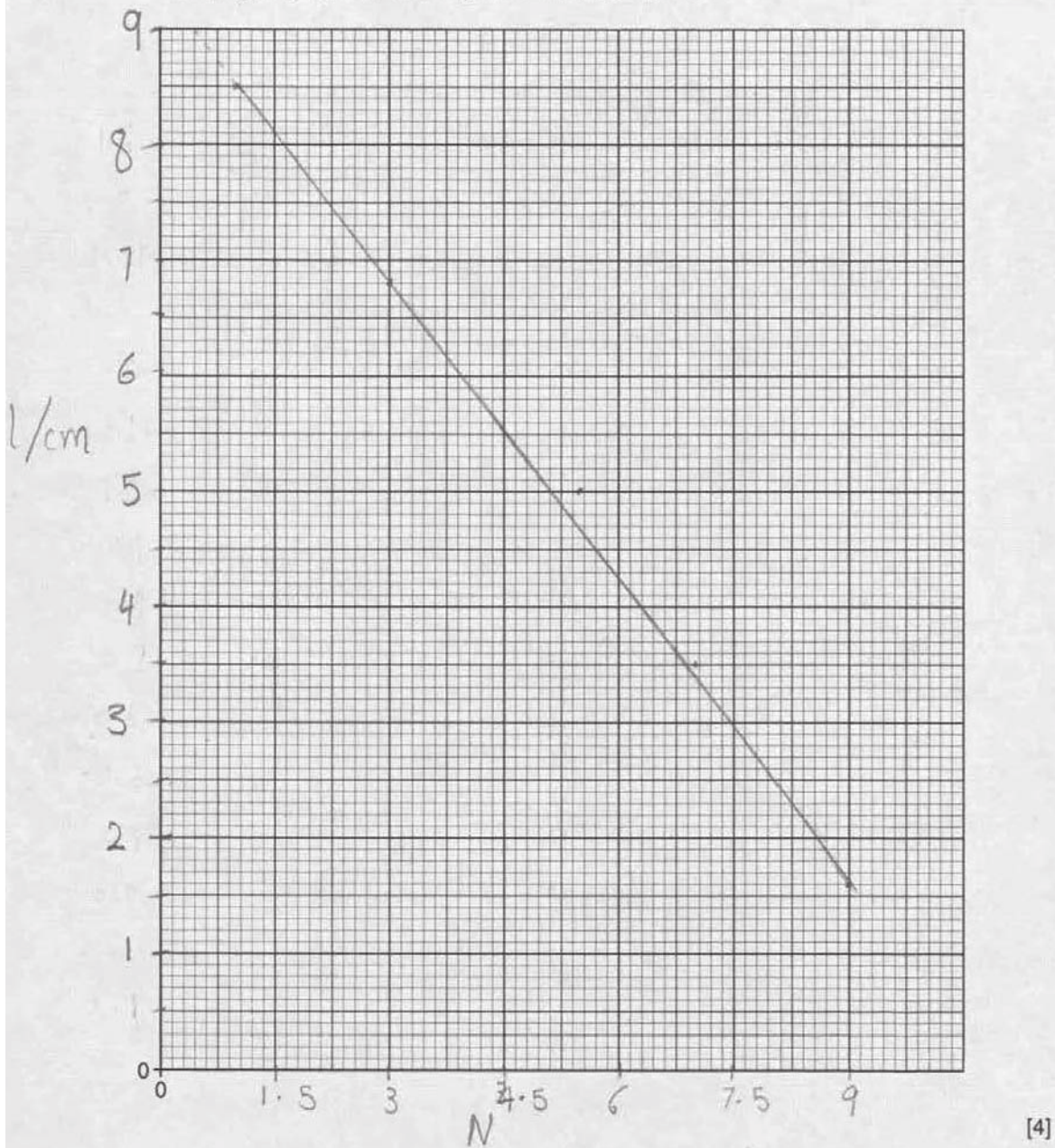

Fig. 1.3

- (ii) Describe the relationship between  $l$  and  $N$ .

As  $l$  decreases  $N$  increases  $l/\text{cm}$  decreases  
~~As  $l$  decreases  $N$  increase so~~  
 $l$  is inversely proportional to  $N$ . [2]

(iii) Use the graph to estimate the smallest number of bands needed to sink the rod.

number of bands = ..... 2 ..... [1]

(c) Explain why it is important to use identical rubber bands.

So that we can get equal  
~~an~~ amount of decrease in length above  
 water of rod as it increases accuracy of  
 experiment. [1]

Examiner comment – grade E

- (a) (i) The mark was not awarded here as the tip of the arrow is seen to be higher than the top of the rod.
  - (ii) Parallax error alone would not have scored the mark here but the candidate goes on to explain that this is because the ruler cannot be placed close enough to the rod and so gains this mark.
  - (iii) One mark was given here for using a ruler beside (close to) the rod to make a measurement. However, the use of set squares as described would be difficult in this case and the candidate has not explained how the length measurement would be obtained so the second mark was not given. (2/4)
- (b) This candidate gained one mark for labelling the axes on the graph correctly. The x axis scale is divided up in increments of 1.5 and this makes it almost impossible to correctly plot points. Consequently, the following two marks cannot be awarded. Candidates should aim to use a sensible scale (avoiding multiples of 3, 7 etc.) and to fill as much of the graph paper as possible. The mark for the best fit line was not awarded as more points are above the line than below it. The candidate correctly described the trend as  $N$  increases  $l$  decreases but does not gain the second mark. No mark is awarded in part (iii). (2/7)
- (c) The candidate states that identical rubber bands will increase the accuracy of the experiment which does not gain the mark. (0/1)

**Total mark awarded = 4 out of 12**

## Question 2

### Mark scheme

- 2 (a) current  $\text{cao}$  [B1]
- (b) **any one from** [B1]  
 (low resistance) does not decrease current (much)  
 high resistance would decrease the current  
 (low resistance) ammeter reads a large(r) value (than high R ammeter)  
 current is high(er)  
 very little p.d. across it
- (c) 0.67 A  $\text{cao}$  [B1]
- (d) **any one from** [B1]  
 no parallax error  
 needle does not stick  
 easier to read / measure (current)  
 easier to change range  
 lower resistance
- (e) (i) **current** is same in series circuit / no junctions / single loop [B1]
- (ii) **any one from** [B1]  
 meters not identical / exactly the same  
 zero error in meter  
 different calibration / calibration error
- [6]



## Example candidate response – grade A

2 A student investigates the use of ammeters in a circuit.

(a) State the quantity measured with an ammeter.

..... Current ..... [1]

(b) Explain why it is important for an ammeter to have a low resistance.

..... so that it does not affect the current flowing  
..... in the circuit, as high resistance decrease current. [1]

(c) Fig. 2.1 shows an analogue ammeter.

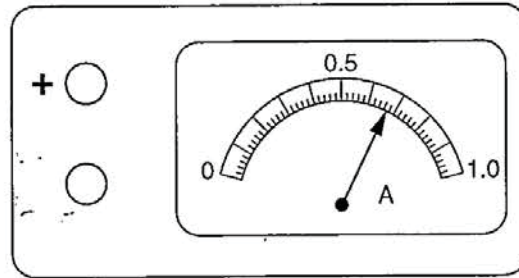

Fig. 2.1

State the reading on the ammeter.

..... reading = 0.67 A ..... [1]

(d) A school has both digital and analogue ammeters.

Suggest one advantage of using a digital ammeter rather than an analogue ammeter.

..... no chance of parallax error so digital is better  
..... and gives accurate reading. [1]

(e) Fig. 2.2 shows a simple circuit.

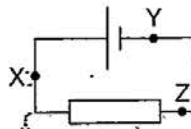

Fig. 2.2

A student connects three similar ammeters at X, at Y and at Z. The ammeters give slightly different readings.

(i) Explain why all the ammeters should give the same reading.

..... should give same reading as in series circuit  
..... current does not divide and is same throughout the circuit. [1]

(ii) Suggest a reason for the slight differences in the three readings.

..... Ammeters may have slight <sup>zero</sup> error i.e. needles of them  
..... were not exactly at zero before measuring current. [1]

## Examiner comment – grade A

- (a) Correct answer of current. (1/1)
- (b) The response required here is that a high resistance would decrease the current and this candidate has clearly stated this. (1/1)
- (c) The candidate needed to read the scale accurately to gain the mark here. No margin of error was allowed. (1/1)
- (d) The candidate correctly stated that there would be no parallax error possible with a digital meter (this would not be the case with an analogue meter). (1/1)
- (e) The candidate is expected to recognise in part (i) that this is a series loop in which the current will be the same throughout. In part (ii) the candidate is expected to give a reason why the readings may differ slightly. This can only be due to a difference in the meters and not anything else in the circuit. This candidate correctly suggested a zero error in the meter. (2/2)

**Total mark awarded = 6 out of 6**

Example candidate response – grade C

2 A student investigates the use of ammeters in a circuit.

(a) State the quantity measured with an ammeter.

It is current. [1]

(b) Explain why it is important for an ammeter to have a low resistance.

So that current can easily flow and ammeter can measure it [1]

(c) Fig. 2.1 shows an analogue ammeter.

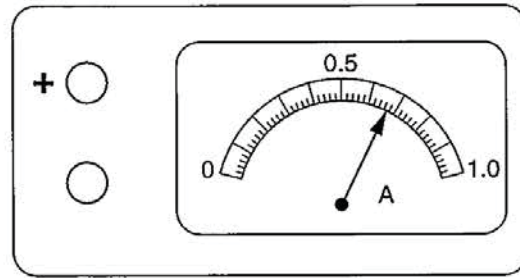

Fig. 2.1

State the reading on the ammeter.

reading = 0.6 A [1]

(d) A school has both digital and analogue ammeters.

Suggest one advantage of using a digital ammeter rather than an analogue ammeter.

It is reliable and gives accurate reading. [1]

(e) Fig. 2.2 shows a simple circuit.

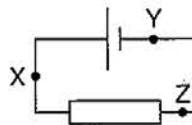

Fig. 2.2

A student connects three similar ammeters at X, at Y and at Z. The ammeters give slightly different readings.

(i) Explain why all the ammeters should give the same reading.

As it is a series circuit and same current flows through out a series circuit. [1]

(ii) Suggest a reason for the slight differences in the three readings.

The fixed resistor used causes resistance so ammeter readings decrease slightly. [1]

## Examiner comment – grade C

- (a)** The quantity is correctly stated as current. (1/1)
- (b)** No mark is awarded here. The statement that the current can flow easily is not incorrect but it does not define the relationship between current and resistance. (0/1)
- (c)** The scale was read correctly and the mark is gained. (1/1)
- (d)** Many candidates think (incorrectly) that digital meters are more accurate than analogue meters. A digital meter is easier to read and therefore the candidate is less likely to err in taking a reading but this does not mean that the instrument is more accurate. No mark awarded here. (0/1)
- (e)** The candidate gained the mark in part **(i)** for correctly identifying that the current is the same throughout the series loop. However, the mark in part **(ii)** is not gained. The fixed resistor would have had the same effect on all three ammeters. The difference can only be explained by a difference in the meters themselves. (1/2)

**Total mark awarded = 3 out of 6**

### Example candidate response – grade E

2 A student investigates the use of ammeters in a circuit.

(a) State the quantity measured with an ammeter.

Amperes.....[1]

(b) Explain why it is important for an ammeter to have a low resistance.

This is because if the current is low compared to its resistance, then there will be no reading.....[1]

(c) Fig. 2.1 shows an analogue ammeter.

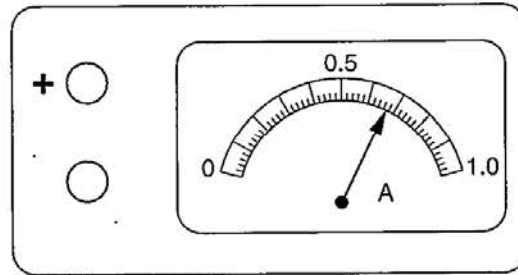

Fig. 2.1

State the reading on the ammeter.

reading = 0.66 A.....[1]

(d) A school has both digital and analogue ammeters. Suggest one advantage of using a digital ammeter rather than an analogue ammeter.

more accurate and easy to get readings.....[1]

(e) Fig. 2.2 shows a simple circuit.

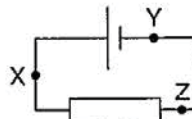

Fig. 2.2

A student connects three similar ammeters at X, at Y and at Z. The ammeters give slightly different readings.

(i) Explain why all the ammeters should give the same reading.

This is because the same current is supplied to the whole circuit.....[1]

(ii) Suggest a reason for the slight differences in the three readings.

This is because the current that went through resistor from the battery is larger compared to ~~is~~ when coming out the resistor.....[1]



### Examiner comment – grade E

- (a) This candidate has not understood the difference between a quantity and its unit. This error was not unusual on this paper. (0/1)
- (b) This response indicated a low level of understanding of the relationship between current and resistance. (0/1)
- (c) The correct answer only could gain the mark here. This candidate was close but the needle was clearly halfway between 0.66 and 0.68 in the diagram so 0.67 A is the correct answer. (0/1)
- (d) This candidate incorrectly thinks a digital meter is more accurate but goes on to explain that it is easy to get the readings. This gets the mark for 'easier to read'. (1/1)
- (e) No mark is awarded in either part of this question. The candidate has a poor understanding of the circuit. (0/2)

**Total mark awarded = 1 out of 6**

## Question 3

### Mark scheme

- 3 (a) (i) normal correct at P [B1]
- (ii) angle r correct  $\pm 1^\circ$  [B1]
- (b) (iii)  $2.8 \pm 0.1$  cm [B1]  
 $6.9 \pm 0.1$  cm unit required on at least **one** response
- (v)  $5.3 \pm 0.1$  (cm) [B1]  
 $8.2 \pm 0.1$  (cm)
- (vi) 1.6 or ecf correct ratio calculated no unit [B1]
- (c) emergent ray drawn parallel to incident ray and **labelled L** [B1]
- [6]

## Example candidate response – grade A

3 An experiment is carried out to investigate refraction of light through a glass block.

Fig. 3.1 shows a rectangular glass block. A ray of light is incident at P at an angle of incidence of  $40^\circ$ . The angle of refraction in the block is  $24^\circ$ .

(a) On Fig. 3.1, draw lines to represent

(i) the normal at P, [1]

(ii) the refracted ray. [1]

(b) The lower face of the block is labelled XY.

(i) On Fig. 3.1, continue the normal to meet XY. Label this point A.

(ii) On Fig. 3.1, continue the line of the refracted ray to meet XY. Label this point B.

(iii) Measure AB and PB.

AB = ..... 2.8 cm .....

PB = ..... 6.9 cm .....

[1]

(iv) On Fig. 3.1, continue the line of the incident ray to meet XY. Label this point C.

(v) Measure AC and PC.

AC = ..... 5.2 cm .....

PC = ..... 8.2 cm .....

[1]

(vi) Theory suggests that the refractive index of the glass is given by the ratio

$$\frac{AC \times PB}{AB \times PC}$$

Calculate this ratio.

Give your answer to a suitable number of significant figures.

$$= \frac{5.2 \times 6.9}{2.8 \times 8.2} = 1.562$$

$$\approx \boxed{1.56}$$

ratio = ..... 1.56 ..... [1]

(c) On Fig. 3.1, draw a line to represent the ray of light that emerges from the block.

Label this line L.

[1]

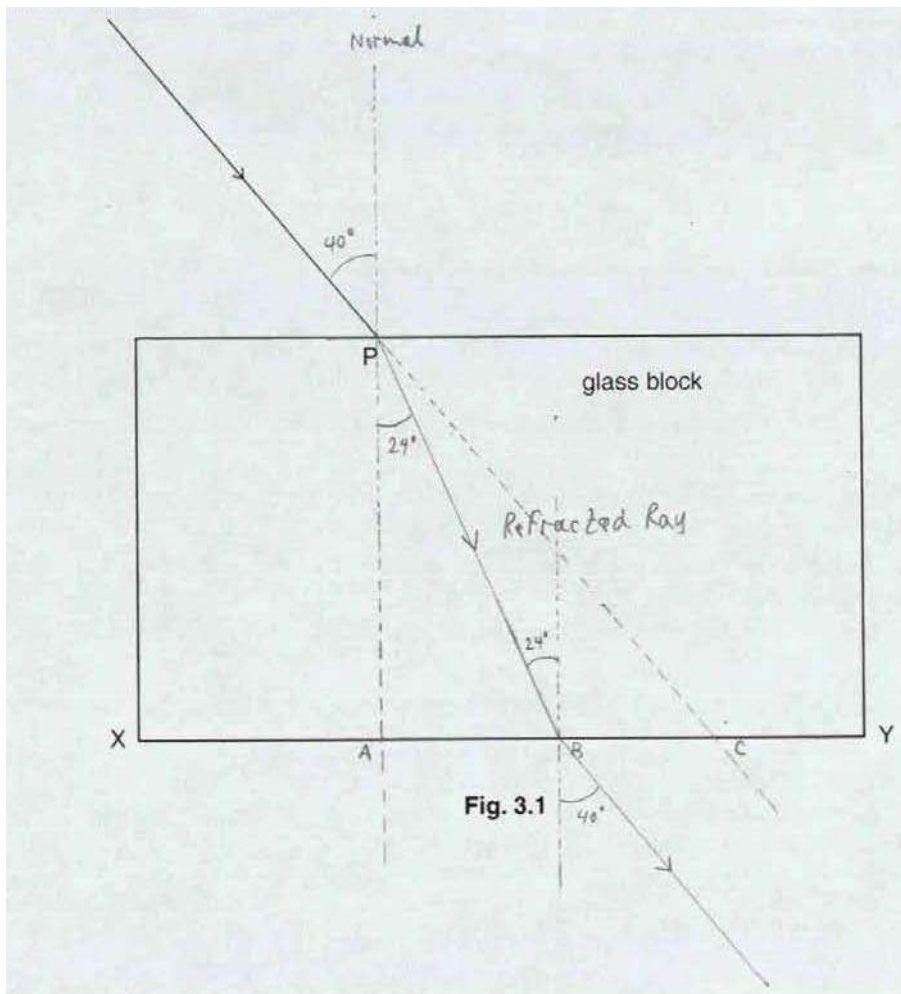

### Examiner comment – grade A

- (a) The examiner is looking to see how well the candidate can obey a series of instructions. A sharp pencil and a protractor are essential items here. This candidate correctly drew the normal and the refracted ray within the allowed tolerance for the angle. (2/2)
- (b) Again, the candidate needed to follow the instructions given and then make the required measurements to the nearest 0.1 cm. A small tolerance was allowed in the expected measurements. Each measurement should also have a correct unit. This candidate gained both marks here. In part (vi) the candidate is expected to use his measurements and calculate a given ratio. He is also expected to give a suitable number of significant figures in his answer. No unit should be seen as it is a ratio. This candidate correctly calculated the ratio from his readings and gave the answer to 3 significant figures (2 or 3 were acceptable here). (3/3)
- (c) The candidate correctly drew a line to represent the ray of light emerging from the block. However, the line was not labelled L as instructed. Unfortunately, this meant that the mark was not gained. (0/1)

**Total mark awarded = 5 out of 6**

## Example candidate response – grade C

3 An experiment is carried out to investigate refraction of light through a glass block.

Fig. 3.1 shows a rectangular glass block. A ray of light is incident at P at an angle of incidence of  $40^\circ$ . The angle of refraction in the block is  $24^\circ$ .

(a) On Fig. 3.1, draw lines to represent

(i) the normal at P, [1]

(ii) the refracted ray. [1]

(b) The lower face of the block is labelled XY.

(i) On Fig. 3.1, continue the normal to meet XY. Label this point A.

(ii) On Fig. 3.1, continue the line of the refracted ray to meet XY. Label this point B.

(iii) Measure AB and PB.

AB = ..... 2.79 cm ..... [1]

PB = ..... 6.85 cm ..... [1]

(iv) On Fig. 3.1, continue the line of the incident ray to meet XY. Label this point C.

(v) Measure AC and PC.

AC = ..... ~~5.9 cm~~ 5.45 cm ..... [1]

PC = ..... ~~8.3 cm~~ 8.30 cm ..... [1]

(vi) Theory suggests that the refractive index of the glass is given by the ratio

$$\frac{AC \times PB}{AB \times PC}$$

Calculate this ratio.

Give your answer to a suitable number of significant figures.

$$\frac{\cancel{5.9} \times 6.85}{\cancel{8.3} \times \cancel{2.79}} = \cancel{1.73} \quad \frac{5.45 \times 6.85}{2.79 \times 8.30}$$

ratio = ..... ~~1.73~~ 1.61 ..... [1]

(c) On Fig. 3.1, draw a line to represent the ray of light that emerges from the block.

Label this line L. [1]

$$\frac{\sin r}{\sin i} = 1.73$$

$$\frac{\sin 24^\circ}{\sin i} = 1.73$$



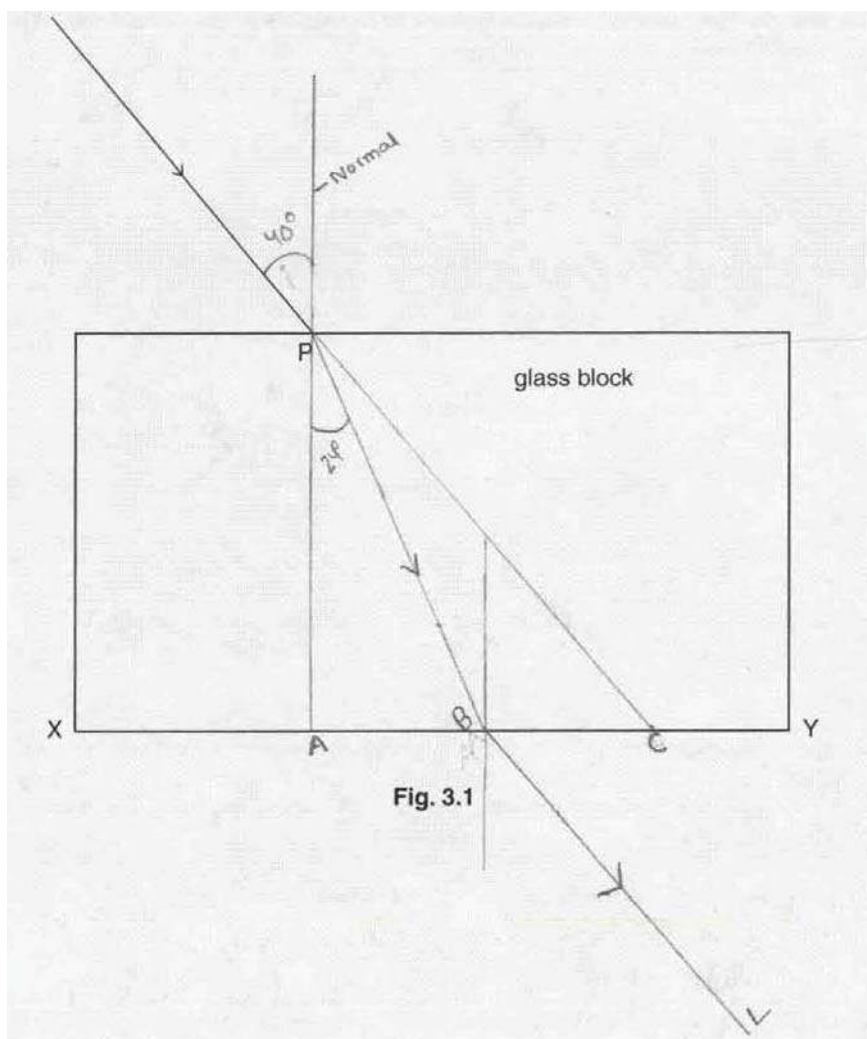

Fig. 3.1

### Examiner comment – grade C

- (a) The candidate followed the instructions and his diagram was clear. Both marks awarded here. (2/2)
- (b) The candidate continued to follow the instructions given and his diagram was good. However, it is important, when taking measurements, that the recorded values are sensible for the instrument used. It is not possible to record a length to the nearest 0.01 cm using a ruler. At best, the measurement can only be made to the nearest half millimetre (0.05 cm). Consequently the reading of 2.79 cm for AB in part (iii) meant that this mark was not awarded. In part (iv), the recorded values were to the nearest half millimetre but the reading of  $AC = 5.45$  cm was outside the range allowed for this measurement so again no mark was awarded. In part (vi) the candidate used his values to correctly calculate the ratio and gained this mark. (1/3)
- (c) The emerging ray was drawn correctly and labelled L, gaining this mark. (1/1)

**Total mark awarded = 4 out of 6**

## Example candidate response – grade E

3 An experiment is carried out to investigate refraction of light through a glass block.

Fig. 3.1 shows a rectangular glass block. A ray of light is incident at P at an angle of incidence of  $40^\circ$ . The angle of refraction in the block is  $24^\circ$ .

(a) On Fig. 3.1, draw lines to represent

- (i) the normal at P, [1]  
 (ii) the refracted ray. [1]

(b) The lower face of the block is labelled XY.

- (i) On Fig. 3.1, continue the normal to meet XY. Label this point A.  
 (ii) On Fig. 3.1, continue the line of the refracted ray to meet XY. Label this point B.  
 (iii) Measure AB and PB.

AB = ..... 2.8 cm .....

PB = ..... 7.1 cm .....

[1]

(iv) On Fig. 3.1, continue the line of the incident ray to meet XY. Label this point C.

(v) Measure AC and PC.

AC = ..... 5.1 cm .....

PC = ..... 8.2 cm .....

[1]

(vi) Theory suggests that the refractive index of the glass is given by the ratio

$$\frac{AC \times PB}{AB \times PC}$$

Calculate this ratio.

Give your answer to a suitable number of significant figures.

$$\frac{AC \times PB}{AB \times PC} \quad \left| \quad \frac{5.1 \times 7.1}{2.8 \times 8.2} = 1.577 \approx 1.6$$

ratio = ..... 1.577 .....

[1]

(c) On Fig. 3.1, draw a line to represent the ray of light that emerges from the block.

Label this line L.

[1]

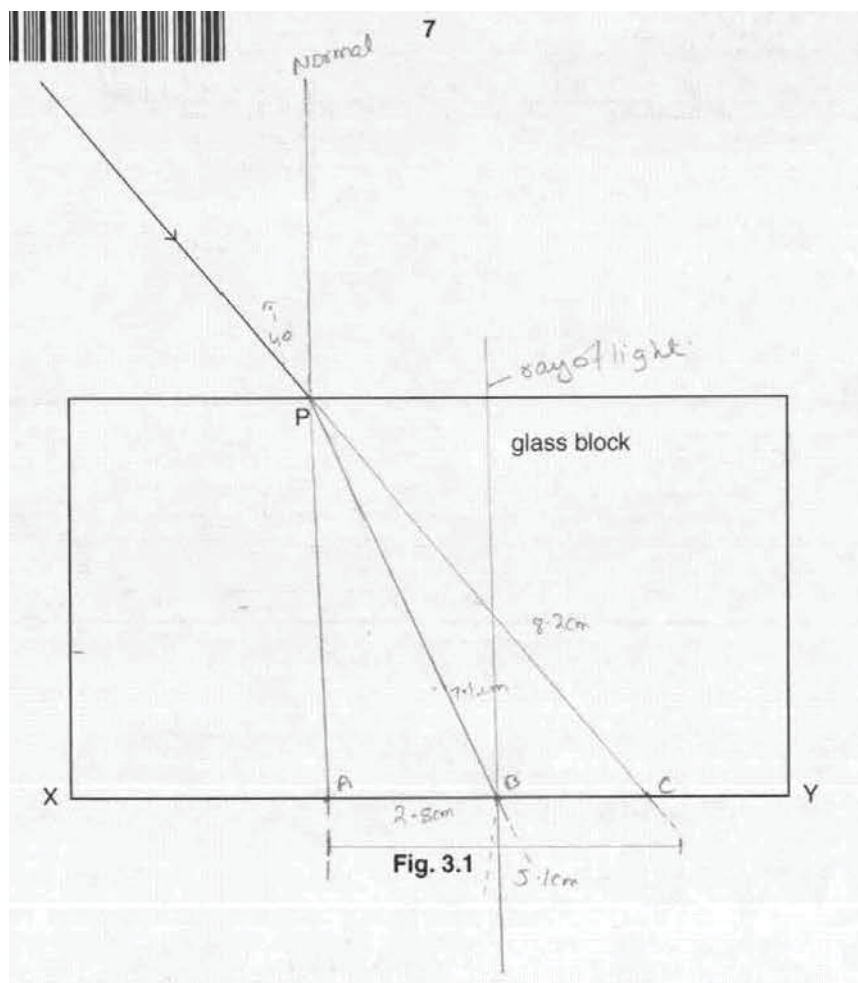

### Examiner comment – grade E

- (a) The candidate followed the instructions and his diagram was clear. Both marks awarded here. (2/2)
- (b) The candidate lost marks here due to the inaccuracy of his measurements. In part (iii), the measurement for AB was correct but the measurement for PB was out to tolerance, so no mark scored. Again in part (iv), the measurement for AC was out of the allowed range so this mark was not scored. In part (vi), it is the answer on the answer line that is marked when two possible answers are given. The ratio needed to be given to 2 or 3 significant figures so the answer on the line of 1.577 did not score the mark. The answer in the working of 1.6 would have been correct but this could not score. (0/3)
- (c) The candidate did not draw an emerging ray so no mark scored. Candidates need to ensure that they have answered all of each question. (0/1)

**Total mark awarded = 2 out of 6**

## Question 4

### Mark scheme

- 4 (a) (i)  $(V = ) l \times w \times h$  seen [B1]
- 7.6 cm and 2.6 cm and 1(.0) cm seen [B1]
- height or volume / 10 [B1]
- $2.0 \text{ cm}^3$  cao unit required [B1]
- (ii) **any one from** [B1]  
 makes thickness of one slide/height/volume/density/result more accurate  
 slides are thin  
 slides may vary in thickness  
 gives average value for thickness of one slide
- (b) scales/balance [B1]
- [6]

### Example candidate response – grade A

- 4 An experiment is carried out to determine the density of the glass used to make microscope slides. Fig. 4.1 shows a stack of 10 microscope slides.

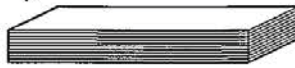

Fig. 4.1 (not to scale)

Fig. 4.2 shows full-size views of the stack of microscope slides.

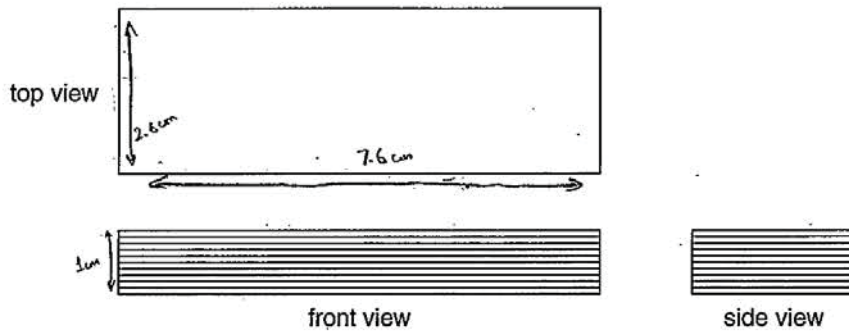

Fig. 4.2 (full size)

- (a) (i) By taking measurements from Fig. 4.2, determine the average volume of a microscope slide.  
State clearly any measurements taken and show how the volume is calculated.  
Give your answer to 2 significant figures.

$$\begin{aligned} \text{volume of all together} &= l \times b \times h \\ &= 7.6 \times 2.6 \times 1 \\ &= 19.76 \text{ cm}^3 \end{aligned}$$

$$\begin{aligned} \text{volume of one} &= \frac{19.76}{10} \\ &= 1.976 \text{ cm}^3 \approx 2.0 \text{ cm}^3 \end{aligned}$$

volume = ..... 2.0 cm<sup>3</sup> ..... [4]

- (ii) Explain why a stack of 10 slides is used rather than just one slide.

..... This ..... is ..... because ..... the ..... height ..... of ..... one ..... slide ..... is ..... too ..... difficult ..... to ..... measure ..... resulting ..... in ..... parallax ..... error ..... as ..... compared ..... with ..... 10 ..... slides ..... [1]

- (b) State any additional equipment needed to find the density of the glass.

..... electronic balance (to measure mass) ..... [1]



## Examiner comment – grade A

- (a) The candidate was expected to find the volume of a stack of ten microscope slides and then divide the volume by 10 to get the volume of one slide, giving the answer to 2 significant figures. This candidate showed the measurements and working clearly at each stage. The answer of  $1.976 \text{ cm}^3$  was then correctly expressed as  $2.0 \text{ cm}^3$  to 2 significant figures. All four marks scored. (4/4)
- (b) In explaining why 10 slides should be used, the examiner is looking for the candidate to identify that the height/thickness of one slide would be difficult to measure accurately using a ruler. This candidate gained the mark here. (1/1)
- (c) An electronic balance was correctly identified as the additional equipment to find the density of the glass. (1/1)

**Total mark awarded = 6 out of 6**

Example candidate response – grade C

- 4 An experiment is carried out to determine the density of the glass used to make microscope slides. Fig. 4.1 shows a stack of 10 microscope slides.

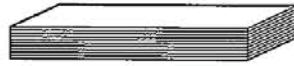

Fig. 4.1 (not to scale)

Fig. 4.2 shows full-size views of the stack of microscope slides.

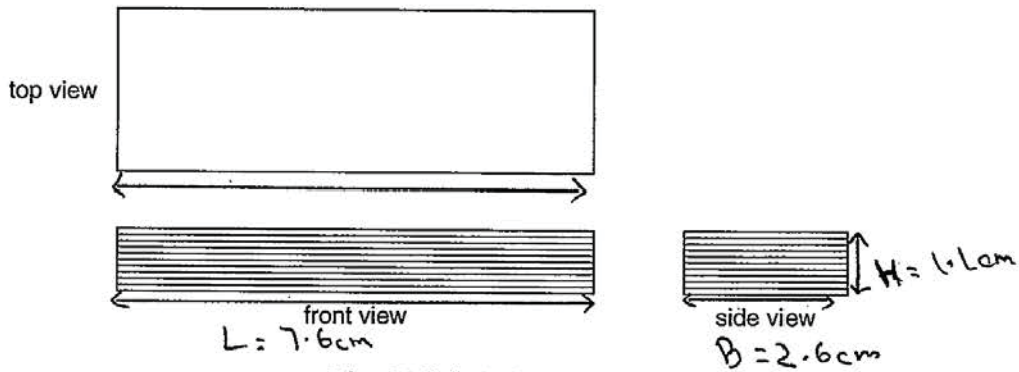

Fig. 4.2 (full size)

- (a) (i) By taking measurements from Fig. 4.2, determine the average volume of a microscope slide. State clearly any measurements taken and show how the volume is calculated. Give your answer to 2 significant figures.

$$\text{Vol} = L \times b \times h \quad (L = 7.6 \text{ cm}, b = 2.6 \text{ cm}, h = 1.1 \text{ cm})$$

$$= 7.6 \times 2.6 \times 1.1$$

$$= 21.74$$

OR

$$\text{avg vol of 10 slides} = \frac{21.74}{10} = 2.174 = 2.2$$

1 of 10 = 22 cm<sup>3</sup> } volume = 2.2 cm<sup>3</sup> [4]

- (ii) Explain why a stack of 10 slides is used rather than just one slide.

Just one slide is too small to be measured and error can occur. There is very less chance of error in taking average. [1]

- (b) State any additional equipment needed to find the density of the glass.

As density =  $\frac{\text{mass}}{\text{vol}}$ , so for mass we need beam balance. [1]

### Examiner comment – grade C

- (a) This candidate understood the principles required to answer the question and used the correct equation to find the volume and gained the first mark. The measurement of the height of the stack was incorrect so the second mark was not given. The candidate gained the third mark for dividing his volume by 10 but the fourth mark was for 'correct answer only' so not given. (2/4)
- (b) This answer was not precise enough to gain the mark. 'One side' could refer to any of the three lengths measured. (0/1)
- (c) The candidate correctly suggested a beam balance to find the mass and hence the density. (1/1)

**Total mark awarded = 3 out of 6**

Example candidate response – grade E

- 4 An experiment is carried out to determine the density of the glass used to make microscope slides. Fig. 4.1 shows a stack of 10 microscope slides.

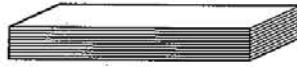

Fig. 4.1 (not to scale)

Fig. 4.2 shows full-size views of the stack of microscope slides.

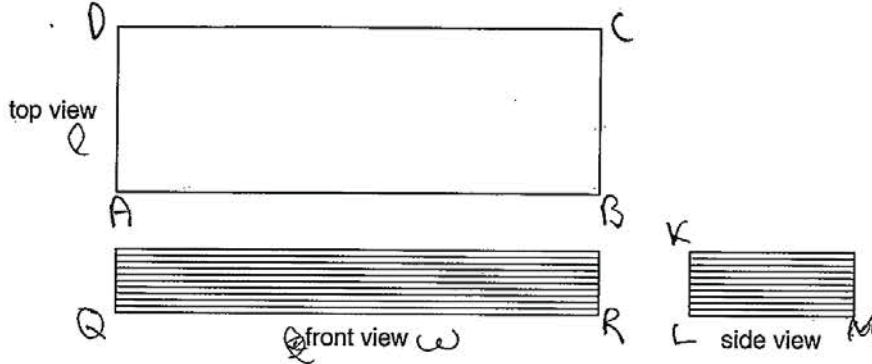

Fig. 4.2 (full size)

- (a) (i) By taking measurements from Fig. 4.2, determine the average volume of a microscope slide.

State clearly any measurements taken and show how the volume is calculated.

Give your answer to 2 significant figures.

$AB = 7.5$ ,  $QR = 7.6 \text{ cm}$ , Average =  $\frac{7.5 + 7.6}{2} = 7.55$   
 $AD = 2.6$ ,  $KL = 2.6$ , Average =  $\frac{2.6 + 2.6}{2} = 2.6$   
 $\text{Volume} = l^3 \times w^3$   
 $\text{Volume} = 7.55^3 \times 2.6^3$   
 $\text{Volume} = 430.4 \times 17.6$   
 $\text{Volume} = 7564.7 \text{ m}^3$   
 volume =  $7564.7 \text{ m}^3$  ..... [4]

- (ii) Explain why a stack of 10 slides is used rather than just one slide.

Because one slide has very less volume by which we can not determine density ..... [1]

- (b) State any additional equipment needed to find the density of the glass.

Beam balance by which we determine the mass ..... [1]

### Examiner comment – grade E

- (a) This candidate did not use the correct equation to find the volume and his measurements were not correct. No marks could be awarded. (0/4)
- (b) The candidate failed to understand why finding the dimensions of a single slide would be inappropriate. (0/1)
- (c) The beam balance was correctly identified here. (1/1)

**Total mark awarded = 1 out of 6**



Cambridge International Examinations  
1 Hills Road, Cambridge, CB1 2EU, United Kingdom  
Tel: +44 (0)1223 553554 Fax: +44 (0)1223 553558  
Email: [info@cie.org.uk](mailto:info@cie.org.uk) [www.cie.org.uk](http://www.cie.org.uk)

© Cambridge International Examinations March 2015 v1



<https://xtremepape.rs/>

